

AA2006-3

AIRCRAFT ACCIDENT INVESTIGATION REPORT

AKAGI HELICOPTER COMPANY LIMITED.
AEROSPATIALE SA315B ALOUETTE III (ROTORCRAFT), JA6119
MISUGI VILLAGE, ICHISHI DISTRICT
(TSU CITY FROM JANUARY 2, 2006),
MIE PREFECTURE, JAPAN
AT ABOUT 15:50 JST, OCTOBER 18, 2005

July 28, 2006

Aircraft and Railway Accidents Investigation Commission
Ministry of Land, Infrastructure and Transport

The investigation for this report was conducted by Aircraft and Railway Accidents Investigation Commission, ARAIC, about the aircraft accident of Akagi Helicopter Company Limited Aerospatiale SA315B ALOUETTE III helicopter in accordance with Aircraft and Railway Accidents Investigation Commission Establishment Law and Annex 13 to the Convention of International Civil Aviation for the purpose of determining cause of the aircraft accident and contributing to the prevention of accidents and not for the purpose of blaming responsibility of the accident.

This English version report has been published and translated by ARAIC to make its reading easier for English speaking people those who are not familiar with Japanese. Although efforts are made to translate as accurate as possible, only the Japanese version is authentic. If there is difference in meaning of the texts between the Japanese version and the English version, texts in the Japanese version are correct.

Junzo Sato,
Chairman,
Aircraft and Railway Accidents Investigation Commission

AIRCRAFT ACCIDENT INVESTIGATION REPORT

AKAGI HELICOPTER CO., LTD.
AEROSPATIALE SA315B ALOUETTE III (ROTORCRAFT), JA6119
MISUGI VILLAGE, ICHISHI DISTRICT (TSU CITY FROM JANUARY 2, 2006),
MIE PREFECTURE, JAPAN
AT ABOUT 15:50 JST, OCTOBER 18, 2005

July 12, 2006

Decision by the Aircraft and Railway Accidents Investigation Commission
(Aviation Sub-committee Meeting)

Chairman	Junzo Sato
Member	Yukio Kusuki
Member	Susumu Kato
Member	Noboru Toyooka
Member	Yukiko Kakimoto

1. PROCESS AND PROGRESS OF THE ACCIDENT INVESTIGATION

1.1 Summary of the Accident

On October 18 (Tuesday), 2005, an Aerospatiale SA315B ALOUETTE III helicopter, JA6119, operated by Akagi Helicopter Co., Ltd. lost balance while it was hang-carrying a log and crashed halfway up Mount Yagashira in Misugi Village, Ichishi District, Mie Prefecture, around 15:50 Japanese Standard Time (JST).

Both of the two persons onboard the aircraft, namely the pilot-in-command and fellow pilot, were seriously injured.

The aircraft was destroyed with no post-crash fire.

1.2 Outline of the Accident Investigation

1.2.1 Investigative Organization

The Aircraft and Railway Accidents Investigation Commission assigned one investigator-in-charge and one investigator to the accident on October 19, 2005.

1.2.2 Accredited Representative Participating in the Investigation

An accredited representative of the French Republic, the state of design and manufacture of the accident aircraft, took part in this investigation.

1.2.3 Implementation of the Investigation

October 19, 2005	Interviews
October 20 and 21, 2005	On-site investigation and interviews
November 8 and 9, 2005	Interviews

1.2.4 Hearings from Persons relevant to the Cause of the Accident

Hearings were held.

1.2.5 Comment from the Country of Design and Manufacture

Comment was invited from the state of design and manufacture of the accident aircraft.

2. FACTUAL INFORMATION

2.1 History of the Flight

On October 18, 2005, an Aerospatiale SA315B ALOUETTE III (dubbed “Lama”)*¹ helicopter, JA6119 (hereinafter called “the aircraft”), owned and operated by Akagi Helicopter Co., Ltd. (hereinafter called “the Company”), was put into logging service for carrying wire-rope-slung logs from a log lifting site on a slope about half-way up Mount Yagashira to a temporary operation site at Shimonokawa Karasudani, Misugi Village, Ichishi District, Mie Prefecture (hereinafter called “the temporary operation site”). The schedule of the service that day was to shuttle between the log lifting site and the temporary operation site for three rounds, each consisting of about one hour of shuttling, after the last of which the helicopter was to be refueled. Both the pilot-in-command and fellow pilot were aboard the aircraft in the first round of logging. Only the pilot-in-command was aboard in the second round of logging. The aircraft took off from the temporary operation site for the third round of logging with the pilot-in-command in the right seat and the fellow pilot in the left seat at 15:30.

According to statements from the pilot-in-command, the fellow pilot, and the ground worker of the Company, the sequence of operations ending with the crash was as outlined below.

(1) Pilot-in-Command

It was cloudy during flight, and there were winds from northwest. During the second round, the pilot-in-command felt slight difficulty in doing logging operations because of the presence of unfavorable drafts; they, however, did not significantly hinder control of the aircraft. The pilot-in-command did not observe the load meter indication. At the time of briefing before the third round of logging, he told the fellow pilot that northwest winds were getting stronger, making logging more difficult. When the pilot-in-command told the fellow pilot that he felt the winds might challenge his ability to control the aircraft, the latter answered that the winds were not strong enough to matter. At the log lifting site, the winds seemed to be coming from the right when the aircraft was pointing directly toward the mountain slope. In the third round, the pilot-in-command and the fellow pilot took control alternately, calling “You have.” and “I have.” to each other every time one passed control to the other. During the 10th shuttling, when the pilot-in-command was controlling the aircraft, the pilot-in-command attempted to raise a log from the mountain slope with the aircraft pointing directly toward the slope but failed to raise it because the log was not completely severed from the root. The pilot-in-command consequently lowered the log back to the slope. The fellow pilot then said “I have.” and took control, but the next attempt by the fellow pilot to lift the log was also unsuccessful. The fellow pilot then increased the aircraft’s altitude, flew sideways, and

*¹ In the French Republic, the State of Design and Manufacture of the aircraft, the type of the aircraft is defined as “Aerospatiale SA315B Lama”.

reduced the aircraft's altitude a number of times, changing the direction in which the log tipped. There was then radio communication from the ground worker, advising the pilot to lower the log. The pilot-in-command kept his hand on the control stick without applying any force; he does not know whether he made inputs on the control or not.

A short while later, the aircraft suddenly tipped forward for a reason that was unknown to the pilot-in-command but may have been a downward gust of wind. The aircraft advanced 10 to 15 meters forward in a forward-tipped attitude, pointing toward the valley on the left-hand side. As the aircraft tipped even further forward, the pilot-in-command felt himself being tipped forward. At that moment, he felt as though the aircraft had been held in a forward-tipped position by anchoring itself on the ground, but in the next moment he felt that the aircraft had returned to its horizontal position and had floated in air. The pilot-in-command therefore thought that the aircraft would be able to break away from what it was restrained. However, the aircraft then began falling down toward the valley in front at a speed at which it would go down during normal landing. When the aircraft impacted the ground, the engine was still running. Fearing that a running engine after the crash could be dangerous, the pilot-in-command tried to stop the fuel by turning off the fuel lever, but the lever was beyond the reach of his hand. A short while later, the pilot-in-command attempted to turn off the engine selector lever but the engine shut down automatically before his attempt. The pilot-in-command then evacuated from the aircraft.

A switch for cutting the wire rope was provided only for the right seat. There were instances when the pilot-in-command also waited for "Cut" command from the fellow pilot, who was in control of the aircraft, but there was no such command. During the flight, he did not hear any strange engine sound, did not hear any sound that indicated a decrease in the speed of the main rotor blades, and did not experience abnormal vibration in the aircraft.

(2) Fellow Pilot

On the day of the accident, the fellow pilot was instructed by his manager to check the logging-related skill of the pilot-in-command. The aim was not to conduct training or testing based on the operations manual or other relevant regulations; it was to maintain and improve aircraft control skills of the pilot-in-command.

After taking off from the temporary operation site, the pilot-in-command attempted to lift up a log but failed in the attempt. Then the fellow pilot took over the control and maneuvered the aircraft to sling up the log. Having failed to do so, he laid the log back on the slope. At his second attempt, the ground worker radioed a message to him saying, "Will be unsuccessful. Lower it back." The fellow pilot decided to make another attempt and proceeded to do so. Having failed also in the last attempt, the fellow pilot told the pilot-in-command, "Impossible to lift it up. I'll lower it." When he lowered the aircraft and started tilting the log leftward, the aircraft's nose came down without his intervention, pointing at the valley on the left-hand side. At the same time, the aircraft began sinking. Since the pilot-in-command then

held the control stick in his hand, the fellow pilot thought that the pilot-in-command had made control and looked at the pilot-in-command momentarily, but the latter seemed to be making no control inputs, so the fellow pilot thought something odd had happened. Recognizing that the aircraft had started sinking continuously, the fellow pilot pulled up the collective pitch lever, but the forward-tipped attitude of the aircraft suddenly became steeper, exceeding approximately minus 30 degrees and making him feel that the aircraft was falling down toward the valley. He pulled the cyclic stick aft to raise the nose, but the attempt did not have any effect. He thought that the aircraft might fall, and at that moment there was a slow, cyclic whining sound that was not made by the engine. Deeming that moving the collective pitch lever down would lead to a crash as the nose had come down and that moving the lever up would further exacerbate the forward-tipped attitude of the aircraft, the fellow pilot did not make any control input thereafter. There was no noticeable change in engine sound, but the fellow pilot felt for a few seconds that the normally available level of lift was not available. He was not watching such instruments as the tachometer and load meter.

The aircraft advanced eastward, and trees became closer and closer. The fellow pilot deemed that an emergency landing should take place for safety. He saw an open area and stepped on the left rudder pedal, hoping to go to the open area. The nose turned left. The fellow pilot did not cut the wire rope because he feared that doing so might cause an even steeper forward-tipped attitude and thus cause the aircraft to turn over. The nose then went up, and the aircraft seemed as though it would float, but the next moment the aircraft resumed a forward-tipped attitude. A rustling sound gave the fellow pilot a feeling that the main rotor blades were touching trees along the valley, so he believed the aircraft would fall down. Near the end of the fall, the fellow pilot pulled the cyclic stick toward him while tilting it leftward as far as it went in order to prevent the stick from stabbing him in the impact. Until this point, the fellow pilot's inputs on the cyclic stick had no effect, but this last operation of the stick felt, to the fellow pilot, as though it had some effect. The aircraft struck the ground five to six seconds after assuming a forward-tipped attitude.

The fellow pilot hit his face on the front windshield. He got out through the broken front windshield.

(3) Ground Worker of the Company

At the time of the accident, the ground worker was clear of the log lifting site, having moved westward after attaching the wire rope on the log to the auxiliary hook. The aircraft tried to sling up the log, but the attempt was not successful because the log had not been cut free of its root. Following that, the aircraft began tilting the log toward the right while it was pointing toward the slope of the mountain. Some logs can be cut from their roots by swinging them right and left, but repeated swinging is often dangerous. Knowing this danger, the ground worker radioed "Down." to the pilot, prompting him to lay the log down. At that instant, the aircraft was considerably close to the mountain slope in a slightly nose-down attitude. It

seemed to the ground worker that the aircraft was pointing straight toward the slope. There were trees in front of the aircraft, and the aircraft's height above the ground was lower than the height of the treetops. At the next moment, the aircraft seemingly lost balance and it then suddenly plunged while tipping forward. The ground worker could not visually recognize the subsequent series of events since the aircraft was behind a landscape fold, but he heard a slapping sound of a kind that would be made when something was hitting trees, followed by a crashing sound. As he hurried toward the aircraft to rescue the crew, the ground worker perceived the shutting down of the engine. He did not perceive any changes in engine sound while the aircraft was flying.

The accident occurred about half-way up the northern slope of Mount Yagashira in Misugi Village, Ichishi District, Mie Prefecture, at around 15:50.
(See Figures 1 and 3.)

2.2 The Dead, Missing, and Injured

The pilot-in-command and fellow pilot were seriously injured.

2.3 Damage to the Aircraft

2.3.1 Extent of Damage

Substantial

2.3.2 Damage to Aircraft Components

Cockpit:	Destroyed
Main rotor blades:	Blade tips torn off
Engine:	Damaged
Skids and crosstubes:	Torn off
Tail boom:	Torn off near the rear end
Horizontal stabilizer and tail rotor:	Torn off

2.4 Crew Information

(1) Pilot-in-command:	Male, 33 years old
Commercial pilot certificate (rotorcraft):	June 24, 1998
Type rating for single turbine engine (land):	February 24, 1999
1st class aviation medical certificate	
Validity:	Until January 10, 2006
Total flight time:	2,366 hours and 5 minutes
Flight time in the last 30 days:	71 hours and 40 minutes
Flight time on the aircraft type:	2,128 hours and 9 minutes

Flight time in the last 30 days: 71 hours and 40 minutes

- (2) Fellow Pilot: Male, 51 years old
- | | |
|---|-----------------------------|
| Commercial pilot certificate (rotorcraft): | September 9, 1983 |
| Type rating for single turbine engine (land): | September 9, 1983 |
| 1st class aviation medical certificate | |
| Validity: | Until October 12, 2006 |
| Total flight time: | 11,513 hours and 45 minutes |
| Flight time in the last 30 days: | 61 hours and 17 minutes |
| Flight time on the aircraft type: | 10,948 hours and 12 minutes |
| Flight time in the last 30 days: | 61 hours and 17 minutes |

(3) The pilot-in-command and fellow pilot had both been skill-tested in accordance with the company's regulations and were each qualified to serve as a pilot-in-command. The fellow pilot was additionally qualified to serve as an instructor.

2.5 Aircraft Information

2.5.1 Aircraft

Type:	Aerospatiale SA315B Alouette III
Aircraft serial number:	1234/38
Date of manufacture:	January 1, 1959
Certificate of airworthiness:	DAI-16-586
Validity:	Until December 21, 2005
Categories:	Rotorcraft, normal category, and special aircraft category
Total flight hours:	10,215 hours and 18 minutes
Flight time since last 400-hour inspection (September 15, 2005)	187 hours and 37 minutes

(See Figure 2.)

2.5.2 Weight and Balance

It is estimated that at the time of the accident the weight of the aircraft was approximately 2,194kg (including about 700kg for the log) and the center of gravity approximately 2.97 meters from the reference plane. It is estimated that the weight and center of gravity were within the allowable limits (maximum takeoff weight: 2,300 kilograms; center of gravity for the calculated accident-time weight: between 2.76 and 3.09 meters from the reference plane).

2.6 Meteorological Information

Summarizing the verbal statements given by the pilot-in-command and fellow pilot,

the weather conditions at the crash site at the time of the accident (about 15:50) were as follows:

The wind was blowing mainly from the north and sometimes from the west. The average wind velocity was approximately 15 knots; the wind velocity was varying. Visibility was 10 kilometers or more. The temperature was approximately 15 degrees Celsius.

2.7 Communication Information

Communication between the aircraft and the ground worker was conducted on a company-use radio frequency using radio equipment installed in the aircraft and a transceiver held by the ground worker.

2.8 Accident Site and Wreckage Information

2.8.1 Accident Site Conditions

The accident site was approximately 640 meters above sea level, about half-way up Mount Yagashira in Misugi Village, Ichishi District, Mie Prefecture, on a northern slope that has a gradient of approximately 40°. Stones and gravel were scattered around the site.

The aircraft stopped with its nose pointing westward and its left side downward. Approximately 7 meters up-mountain (southward) from the aircraft, there were impact marks on the ground. On two fallen trees further up-mountain (southward), there were cuts that looked as though they had been made by a sharp-edged implement. The aircraft's tail rotor was on the ground approximately 3 meters east of the aircraft. There were trees with a height of approximately 20 meters standing to the east of the tail rotor. Parts of the trunk and branches of the tree had been severed and had fallen to the ground. The aircraft's right-hand skid had fallen approximately 5 meters down-mountain from the aircraft. On the end of the main hook attached to the bottom of the aircraft, there was a main wire rope of 30 meters in length. On the auxiliary hook at the other end of the main wire rope, there was a lifting wire rope of 7 meters in length. A log with a length of approximately 14 meters and a weight of approximately 700 kilograms was attached to the other end of the lifting wire rope. The end of the log had caught on a tree stump. Fibers near the root end of the log had been torn away. The stump of the wire-attached log was located approximately 11.5 meters northeast of the log, in alignment with the extension of the line on which the log was lying. Part of the trunk had been torn away. From the stump of the wire-attached log to the stump on which the log had caught, there was an uphill gradient.

(See Figure 3 and Photographs 1, 2, 3, and 4.)

2.8.2 Details of Damage to the Aircraft

(1) With regard to the cockpit, the beams running lengthways in the floor were bent and

structural members of the outer framework of the cockpit were destroyed.

- (2) The main rotor blades were severely bent upward and had knocks and abrasions from contact with the trees and ground.
- (3) The engine's rotor case had a hole with a diameter of approximately 30 millimeters in its 12 o'clock position. The edge of the hole was bent inward or toward the engine.
- (4) The right skid was separated from the crosstube at the front of the airframe.
- (5) The tail boom was severed near its aft end.
- (6) The skin of the horizontal stabilizer was torn, and the tail rotor blades were bent.
- (7) The collective pitch lever was in a position near the fully up position. The cyclic stick system was broken.

(See Figure 2 and Photograph 2.)

2.9 Medical and Pathological Information

The pilot-in-command and fellow pilot suffered bruised lungs and other severe injuries.

2.10 Information on Search, Rescue, and Evacuation Having a Bearing on Survival, Death, and Injury

2.10.1 Rescue of Injured Persons after Accident

According to information from the Company and the Nara Prefecture Fire and Disaster Prevention Department, the rescue of the injured persons took place as follows:

Immediately after the accident, the ground worker at the site reported the accident to the Company. A helicopter attached to the Nara Prefecture Disaster Prevention Air Unit took off after receiving a report from the Company indicating that the aircraft had crashed and a mobilization request from the local fire brigade. The rescue helicopter crew found the crash site at 16:43. While airborne above the site, the helicopter winched the pilot-in-command and fellow pilot aboard. The helicopter landed at the Nara Prefecture Heliport. A waiting ambulance transported the two pilots to a hospital.

A rescue helicopter attached to the Mie Prefecture Disaster Prevention Air Unit was also mobilized in connection with the accident. Thus, two rescue helicopters in total were mobilized.

2.10.2 Use of Seatbelts and Other Safety Equipment

During flight, the pilot-in-command wore his seatbelt and a helmet. The fellow pilot wore only his seatbelt.

2.11 Fact-finding Tests and Research

2.11.1 Inspection of Fuel System and Lubrication System

There were 178 liters of remaining fuel in the aircraft, and the fuel filter was free of abnormalities. The amount of engine oil was approximately as specified, and the oil filter was free of abnormalities. No metal fragments were found on the magnetic chip detector.

2.12 Other Relevant Items

2.12.1 Company Regulations

(1) The Company's operations manual contains the following statements regarding the duties of the pilot-in-command (extracted).

The pilot-in-command shall exercise command over the aircraft's operation by performing the following duties and shall bear responsibility for the safety of the aircraft's operation.

(1) Duties before Flight

Confirmation of meteorological information

(2) Duties during Flight

Paying attention to, making appropriate decisions about, and taking appropriate action to deal with changes in the aircraft and weather conditions

(2) The Company's operating standards manual contains the following statements and instructions (extracted) regarding goods transportation and logging operations.

(1) Handling of Emergencies

- In the event of an emergency during flight for hang-carrying goods, the pilot-in-command must first decide whether to detach the slung load. If he/she decides it is not necessary to detach the slung load, he/she must immediately either return to the heliport or make an emergency landing.
- If the slung load catches on an obstacle or the aircraft descends abnormally while the load is being lowered, the pilot-in-command must detach the load after giving the utmost consideration to safety on the ground.

(2) Slinging

When a loaded sling implement such as a wire-rope-slung-carrier become balanced, further increase the pitch and make a transition to a hover while keeping the aircraft perpendicularly above the load. If the aircraft deviates even slightly from the point exactly above the load at this time, the load will be dragged such that it strikes other objects, creating a serious hazard for ground workers. You must, therefore, keep the aircraft perpendicularly above the load while making the transition to a hover.

(3) Meteorological Conditions (Limitations)

The wind velocity must, as a general rule, be no higher than 10 meters per

second.

Stop working if there is severe turbulence and the load meter's deflection exceeds a load factor of ± 1.5 .

2.12.2 Logging Preparations and Log Harvesting

According to forestry company personnel, logging preparations and log harvesting are performed as follows:

To prevent logs from falling down the slope, woodcutters cut almost all the way through each tree but leave some wood to keep the trunk connected to the root. This wood is called "connecting wood." A few days prior to logging, woodcutters cut the connecting wood and attach wire ropes to each log. Since there are many trees for logging, the woodcutters can fail to cut one or more connecting woods. Typically, a connecting wood that has not been cut will snap off under the mass of the log when the helicopter raises it. If it does not, the log is laid back on the ground and a woodcutter cuts it. There were no woodcutters at the site of the accident. Typically, if there are no woodcutters on site, any laid-back log is transported on a later day by helicopter after its connecting wood being cut by a woodcutter.

3. ANALYSIS

3.1 The pilot-in-command and fellow pilot each held a legitimate commercial pilot certificate and a first-class aviation medical certificate.

3.2 The aircraft had a valid certificate of airworthiness and had undergone the specified maintenance and inspections. With regard to the airframe and engine of the aircraft, it is estimated from the results of inspection of the fuel and lubricating oil systems as mentioned in paragraph 2.11.1 of this document and from the all points given hereafter that the aircraft was not abnormal until the accident occurred.

- (1) The pilot-in-command and ground worker stated that there was no abnormality in the engine sound and main rotor rotation sound during flight and that the engine was running after the aircraft hit the ground.
- (2) Even in a forward-tipped attitude, the aircraft tore the log's fibers and dragged the log 11.5 meters up the slope, indicating that it had the power to move the log.
- (3) There was damage resembling cuts made by sharp blades on the trunk and branches of a standing tree and on knocked-down trees in the vicinity of the point impacted by the aircraft. It is estimated that this damage was caused by contact with the main rotor blades during the sequence of events leading to the aircraft's impact with the ground, so it is considered likely that engine torque was being transmitted to the main rotor blades.

With regard to the hole in the engine's turbine case as mentioned in paragraph 2.8.2 of this document, given the nature of the hole, i.e. it was made from the outside toward the inside, and the condition of the area around the sideways-tipped aircraft, it is estimated that the hole was made by contact with a stone when the aircraft hit the ground.

3.3 As stated in paragraph 2.5.2 of this document, the weight and center of gravity of the aircraft including the slung log were within the allowable limits at the time of the accident. From the weight and altitude at the time of logging, it is estimated that out-of-ground-effect hovering was possible.

3.4 Weather Conditions

According to verbal statements given by the pilot-in-command and fellow pilot, which are also mentioned in paragraph 2.6 of this document, wind with a velocity of approximately 15 knots was blowing mainly from the north and sometimes from the west. It seems that the wind velocity was varying.

The above conditions seem to have been within the limits dictated by the Company's operating standards manual mentioned in paragraph 2.12.1(2) of this document. Since neither

of the pilots was able to check the load meter indication owing to failure to lift the log at the time of the accident, however, whether the drafts were strong enough to justify termination of logging is not known. However, from a verbal statement given by the pilot-in-command as summarized in paragraph 2.1(1) of this document, it is estimated that unfavorable drafts were, while not significantly hindering control of the aircraft, making precise logging operations slightly difficult at the time of the accident.

3.5 Progress of the Accident

(1) Separation from Root of Log to Be Transported

With regard to the particular log that the aircraft was attempting to lift at the time of the accident, it is estimated that a woodcutter of the forestry company neglected to completely sever the connecting wood from the root by oversight or some other reasons before attaching a wire rope to it a few days prior to logging. Also, it is estimated that the ground worker of the Company neglected to check whether the connecting wood had been severed prior to lifting or performed the check but failed to notice that the connecting wood had not been severed.

(2) Advice from Ground Worker, and Continuation of Operation

Prior to the accident, the fellow pilot tried to lift the log but failed to do so. It is estimated that the fellow pilot subsequently continued with the operation because he knew from experience that tipping the log to the left or right would sever the connecting wood and enable the log to be lifted. The ground worker thought that continuing the operation would be dangerous, so he radioed “Down.” to the aircraft, meaning that the pilot should lower the hook or the aircraft.

According to the Company’s operating standards manual mentioned in paragraph 2.12.1(2) of this document, the aircraft must be kept perpendicularly above the load as the transition to a hover is made during a lifting operation. It is also noted in the above-mentioned manual that any deviation, however slight, from the point perpendicularly above the load under the stated condition is dangerous. It is estimated that the pilot’s act of repeatedly increasing the aircraft’s altitude, flying sideways, and reducing the aircraft’s altitude to tip the log from side to side was inappropriate because it might have put the aircraft in danger by causing it to deviate from the point perpendicularly above the log.

(3) Unintended Movement of Aircraft’s Nose and Unintended Forward-Tipped Attitude

According to a verbal statement made by the fellow pilot, when he had said “Impossible to lift it up. I’ll lower it.” and started to reduce altitude, causing the log to start tipping leftward, the aircraft nose came down toward the valley without any intervention from the fellow pilot and, at the same time, the aircraft began sinking.

With regard to the aircraft nose’s unintended downward tip toward the valley on the left and the beginning of the aircraft’s sinking movement, it appears possible that the occurrences listed below were caused. However, it was not possible to determine which of

these occurrences was/were contributory to the aforementioned movement of the aircraft nose.

- ① There was varying-velocity wind with an average velocity of approximately 15 knots, and this wind occasionally blew from the right-hand side, causing a weathervane effect.
- ② The wind occasionally blew from the right-hand side, which caused transiently the tail rotor settling.*2
- ③ When the load resulting from tipping the log acted on the helicopter, there were slight delays in pilot's operation of the collective pitch and rudder controls.
- ④ The special relationship between the factors that were present when the log tipped, such as the wire rope direction, aircraft's heading, aircraft's center of gravity, and position of the main hook, contributed to create a moment acting about the aircraft's center of gravity, which caused the nose of the aircraft to swing.
- ⑤ During the aircraft's descent, a draft rising from the valley caused the main rotor blades' lift to fluctuate.

(4) Aircraft's Reactions to Control Inputs while Restrained by Wire Rope

According to the fellow pilot, he moved the collective pitch lever upward because the aircraft started sinking continuously, but the aircraft suddenly assumed a forward-tipped attitude and felt to the fellow pilot as though it was going to fall toward the valley. Also, the fellow pilot stated that he pulled the cyclic lever toward him to raise the nose but the nose did not come up and, for several seconds, the fellow pilot felt that the normally available degree of lift was not available.

With regard to the unintended shift into a forward-tipped attitude, it seems possible that the fellow pilot's pulling on the collective pitch lever in an attempt to increase lift while the aircraft was restrained by the wire rope resulted in an exacerbated forward-tipped attitude and forward movement.

With regard to the increase in the aircraft's forward-tipped angle, the following sequence of events appears likely to have took place: When the collective pitch lever was pulled upward in an attempt to increase the lift of the main rotor, the wire rope became taut. As theoretically assumable, in the accident aircraft with the main hook located below its center of gravity, the tension of the wire would have caused a moment that acted to tip the aircraft in the direction in which the line of action of the main rotor and the straight line between the main hook and the wire rope's ground restricting point aligned with each other. Next, as theoretically assumable again, when this moment overcame the aircraft attitude

*2 "The tail rotor settling" is a vortex ring state which occurs around a tail rotor under the influence of the movement of a tail rotor and wind, resulting in a state where a tail rotor does not produce the lift corresponding to the ladder input by the pilot, and is unable to control the lateral direction of the aircraft.

control derived from the cyclic pitch control, the aircraft would have tipped in line with the angle of the wire rope. With the aircraft in a position that was not directly above the wire rope's ground restricting point, the main rotor lift would have provided support mainly for the aircraft's weight component of the wire rope direction. The rest of the main rotor lift would have simply increased the tension on the wire, thereby restricting the aircraft's freedom in motion rather than providing support for the component of the aircraft weight in the direction at a right angle to the wire rope. As a result, the aircraft would have been pulled by the gravity component in this direction, continuously increasing the rate of sink as it fell, following an arc whose radius was the length of the wire rope.

It is estimated, then, that the situation in which the fellow pilot felt that the usual degree of lift was not available for a few seconds occurred because the aircraft was restrained by the wire rope. It is estimated, as stated in paragraph 3.2 of this document, that there was no mechanical failure. It was not possible to identify the cyclic whining sound that only the fellow pilot heard.

(5) Temporary Recovery of Attitude and Subsequent Resumption of Forward-Tipped Attitude

According to the pilot-in-command and fellow pilot, after the aircraft first tipped forward, the aircraft nose transiently rose but the aircraft subsequently tipped forward again. It is estimated that the cause of the above series of events was as follows: Because the log was torn from its root, the restraint imposed by the wire rope upon the aircraft momentarily eased during the log's approximately 11.5 meters of movement, allowing the aircraft nose to rise. The log then caught on a stump, and the aircraft returned to a forward-tipped attitude.

(6) Contact of Main Rotor Blades with Trees

It is estimated that the rustling sound heard by the fellow pilot roughly when the aircraft assumed a forward-tipped attitude for the second time was the sound made by the main rotor blades cutting the trees. It is also estimated that the main rotor blades were damaged by the contact with the trees, that their lift further decreased as a result, and that the aircraft then struck the slope.

(7) Impact with Slope

From the fellow pilot's verbal statement that he moved the cyclic stick fully leftward just before the impact with the slope, it is estimated that the main rotor blades and the aircraft's surface under the pilots' seats struck the slope almost simultaneously and that the aircraft then rested on its left side and slid about 7 meters down the slope before stopping. It appears possible that the fellow pilot moved the cyclic stick fully leftward in an attempt to mitigate injuries by preventing the pilot from falling directly forward onto the instruments and cyclic stick during the impact.

(See Figure 3 and Photographs 1, 2, and 4.)

3.6 Main Reason for Non-Detachment of Wire Rope

It is considered likely that the aircraft could have returned to a normal flight attitude and the accident been prevented if the log attached to the main wire rope had been released by means of the main hook or auxiliary hook before the impact with the slope. A device for detaching the main wire was provided only for the right seat, which was occupied by the pilot-in-command.

In the accident, the pilot-in-command was expecting a “Cut” command from the fellow pilot, who was occupying the left seat and was in control of the aircraft. However, the fellow pilot did not give any command to release the log.

It appears possible that the fellow pilot did not give a command to release the log because, as he indicated in a verbal statement, he deemed that cutting the wire rope after the second time the aircraft tipped forward would have caused the aircraft to tip even further forward and hit the slope. However, it seems possible that had the wire rope been cut, the reason for the forward-tipped attitude would have been eliminated, enabling the aircraft to recover a normal attitude. Notably, it appears possible that the crew would have been able to cut the wire rope when the ground worker radioed “Down.”

(See Figures 3, 4-1, and 4-2.)

3.7 Interaction between Personnel

(1) Interaction between Pilots

① Weather-Based Decision to Continue Operations

At the time of briefing before the third round of logging, the pilot-in-command told the fellow pilot that unfavorable drafts were making control more difficult. Aboard the aircraft, too, the pilot-in-command told the fellow pilot that he was concerned about the weather conditions. However, the fellow pilot deemed that the winds were not strong enough to be a problem.

In on-site training, it is necessary to take into consideration the trainee’s skill level and the weather conditions. In the accident, the fellow pilot should have taken the pilot-in-command’s skill level and the weather conditions into consideration in evaluating the advisability of continuing with aircraft operation.

② Company Regulations Regarding Designation of Pilot-in-Command

Before the accident, the pilot-in-command heard, “I have.” from the fellow pilot and passed control to him. It is estimated that the pilot-in-command passed control to the fellow pilot based on the fellow pilot’s judgment, not on his own judgment. Further, since the fellow pilot had a Company instructor qualification, was one of the pilot-in-command’s elders, and was in the position of a checker of the pilot-in-command’s skill level, it appears likely that operational decisions at the time of the accident were being made by the fellow pilot. The Company’s flight operations

manual cited in paragraph 2.12.1(1) of this document states that the pilot-in-command must bear responsibility for the safety of operations. However, it is estimated that during the flight, at the time of accident, the fellow pilot was taking the lead of operating the aircraft, the pilot-in-command, was supposed to be in a leadership position over the flight, considered the feeling of the fellow pilot, found it prohibitively difficult to take actions that he should have taken, e.g. terminating the log-raising operation and cutting the wire rope. It goes without saying that every pilot-in-command is obliged to fulfill his/her mission even when he/she is accompanied by a fellow pilot who is an instructor and one of his/her elders. Nevertheless, it is considered likely that a similar situation will occur at some time in the future. Consequently, the Company should have stipulation that clearly defines the guidelines to be followed when designating the pilot-in-command before those flights in which a person qualified as a pilot-in-command is to be accompanied by another pilot for the purpose of skill-checking or training.

③ Teaching of Flying Skills

According to a verbal statement given by the pilot-in-command, the fellow pilot unsuccessfully attempted to lift the log a number of times. It is estimated that the veteran fellow pilot, in his position as an instructor, was earnestly conveying to the pilot-in-command the skill how to use the small control inputs to make in a situation where lifting a log is difficult. As stated in paragraph 3.5 (2) of this document, however, it is estimated that the control actions were not appropriate. The fellow pilot should, when the log that could not be lifted was encountered, have taught the pilot-in-command how to ensure the safety of the aircraft and ground worker by terminating the lifting operation instead of repeatedly attempting to lift the log.

(2) Interaction between Ground Worker and Pilots

Cargo mirrors are the only means of checking the situation on the ground from the pilots' seats, so information from the ground worker is crucial to the pilots. Further, given the possibility that a slung load might place a ground worker in a dangerous situation and the possibility that, as in the accident, an aircraft itself might get into a dangerous situation, it is vital for pilots to give due regard to information from ground workers as they conduct operations.

3.8 Factors that Mitigated the Harm Suffered

Although the aircraft was seriously damaged and the pilot-in-command and the fellow pilot were seriously injured, the injuries were not fatal. The following factors can probably be attributed to the accident:

(1) The fellow pilot chose a place that was free of obstacles and was able to take the

aircraft to that place.

- (2) It appears likely that the engine's output was close to the maximum output and that the main rotor blades were generating lift large enough for the aircraft to fall and hit the ground at approximately the speed at which it would have been moving for a normal landing.
- (3) Since the aircraft suffered an impact in such a way that it slid down a steep slope, impact force was dispersed by the inclination of the slope. Also, impact force was absorbed by the destruction of structural members of the aircraft.
- (4) Each pilot was wearing a seatbelt.
- (5) The pilot-in-command was additionally wearing a helmet that protected his head.
- (6) The rescue team's helicopter arrived over the accident site within one hour of the accident, and the rescue members were able to promptly administer first aid to the injured pilots and transport them to hospital.

4. PROBABLE CAUSE

With regard to this accident, it is estimated that the aircraft, during repeated attempts by the fellow pilot to lift a log that had not been completely severed from its root, tipped forward, was restrained by the wire rope attached to the log and, owing to the fellow pilot's subsequent upward movement of the collective pitch lever, struck the slope in that condition, resulting in the aircraft being destroyed and the pilots being seriously injured.

5. SAFETY OPINIONS

5.1 Implementation of Checks Related to Safe Lifting of Logs

In the accident, the forestry company did not perform the task of completely severing the log from the root owing to oversight on the part of its workers. It is estimated that, as a result, during the helicopter of the Company attempted to lift the log a few times in order to sever the log from the root, it went out of balance and impacted the ground.

In light of this consequence, it is crucial, from the point of view of preventing a similar accident, for the forestry company to have its workers perform, without any omission, the task of severing logs from their roots and for it to have its workers confirm complete separation of logs from their roots prior to logging operations.

Thus, the Company should demand that the forestry company thoroughly take the aforementioned steps. The Company should also, before lifting logs with a helicopter, have its own ground worker perform a final check to see whether the logs can be safely lifted.

5.2 Establishment of Procedure for Handling Situation where Log Cannot Be Lifted

With regard to the accident, it is estimated that, the Company's pilot, during helicopter logging work, continued lifting the log in an attempt to separate the log from its root. Trying to sever a log from its root using an aircraft can, as in the accident, place the aircraft in danger. In order that no Company pilot makes a second attempt to lift a log after a failed attempt, therefore, it is necessary, at the Company, for such action to be banned by stipulation in the operations manual and operating standards manual and for pilots engaged in this kind of work to be comprehensively trained accordingly.

5.3 Establishment of Guidelines to Be Followed When Designating Pilot-in-Command for Training or Similar Flights

The Company's operations manual states that safety is the responsibility of the pilot-in-command during flight. In the accident, however, the fellow pilot boarded the aircraft in the position of a checker of the pilot-in-command's skill level, initiated flight operations of his own volition, and was teaching flying skills to the pilot-in-command. It is estimated that it was prohibitively difficult for the pilot-in-command to act in accordance with his prescribed professional duties in this situation. Consequently, the Company should have stipulation that clearly defines the guidelines to be followed when designating the pilot-in-command before those flights in which a person qualified as a pilot-in-command is to undergo skill-checking or training.

6. REFERENTIAL MATTERS

6.1 Company Measures to Prevent Recurrence

With regard to the accident, the Company has established the measures listed below for prevention of a recurrence of a similar accident during logging, has given its employees refresher safety-related training, and has revised the contents of its operating standards manual (effective October 18, 2005).

Measures for Prevention of Recurrence of Accident

(1) Complete Severance of Logs

The sales manager of the Company is to strengthen the guidance given to forest owners to ensure that they completely sever logs.

(2) Strengthened Training for Ground Workers

Training for ground workers is to be strengthened to ensure that they confirm that each log has been severed before attaching the wire rope to the hook.

(3) Training Related to Power Settling

All Company pilots are to be given training on power settling.

(4) Procedure for Cutting Wire Rope in Emergency

For all Company pilots who hang-carry cargos, refresher training is to be given on the procedure for cutting the wire rope in an emergency.

(5) Special Inspections for Prevention of Recurrence

The pilots' testimony indicates the possibility of an aircraft malfunction, so special inspections are to be promptly performed on all Company helicopters of the same type in accordance with the maintenance instructions.

(6) Revision of Operating Standards Manual

The operating standards manual does not contain any procedure to be followed when a log gets caught on something, so revisions are to be promptly made. Related training and guidance for pilots and ground workers are to be strengthened.

6.2 Company Measures to Prevent Recurrence (Additional)

As of November 11, 2005, the Company had given its employees the refresher safety-related training detailed below as an additional measure to prevent recurrence.

(1) Refresher training for personnel who have Company instructor qualification

The Company gave refresher training on training methods to the personnel who are qualified to serve as instructors.

(2) Training on crew coordination for all personnel involved with flight operations

The Company gave refresher training on the importance of crew coordination to its pilots, maintenance engineers, and forest workers. In particular, the Company

provided pilots who engage in goods transportation with refresher training on the importance of crew coordination in situations where a load is suspended on a long line and a mirror is the only means of checking conditions on the ground. The Company gave these personnel comprehensive guidance to ensure that they perform reliably problem-free operations.

(3) Enhancement of safety awareness

The Company had all employees focus afresh on safe working practices and give them comprehensive guidance to ensure that they safely perform all operations in a safe working environment.

Figure 1 ASSUMED FLIGHT ROUTE

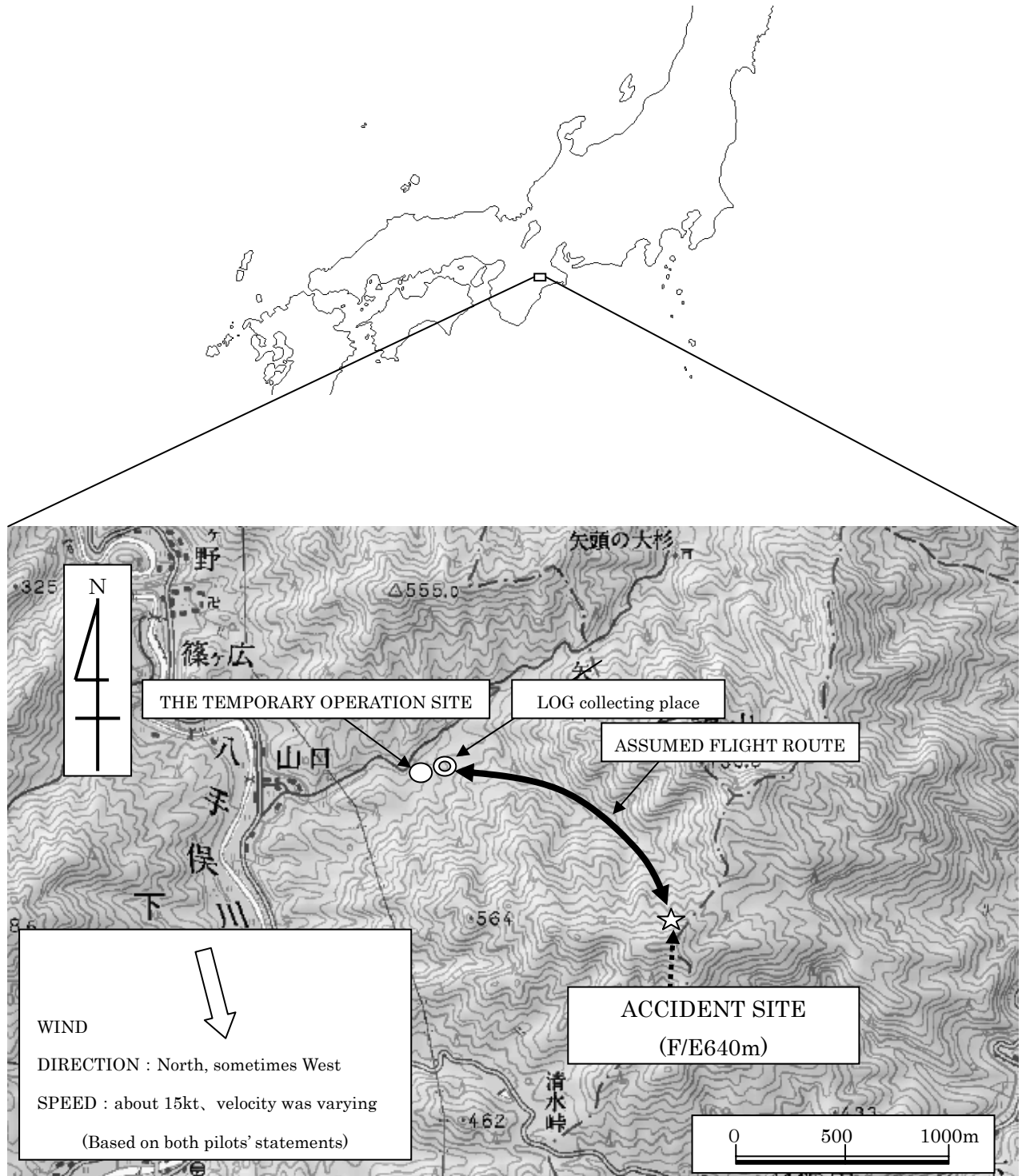

BASED ON 1/50,000 CHART, KOKUDO-CHIRIIN

Figure2 Three views of AEROSPATIALE SA315B
ALOUETTE III(LAMA)

UNIT : m

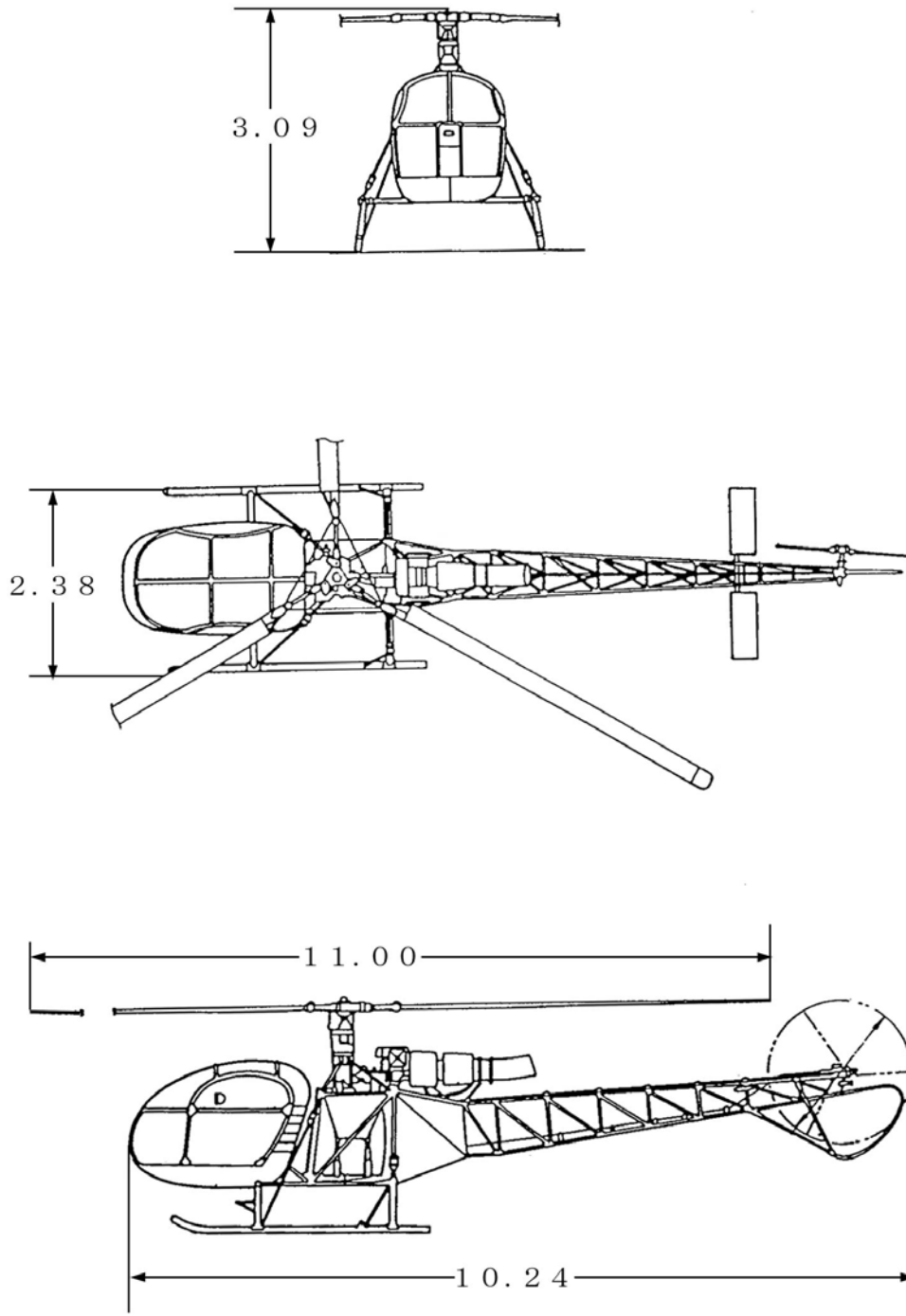

Figure 3 ACCIDENT SITE SCKETCH

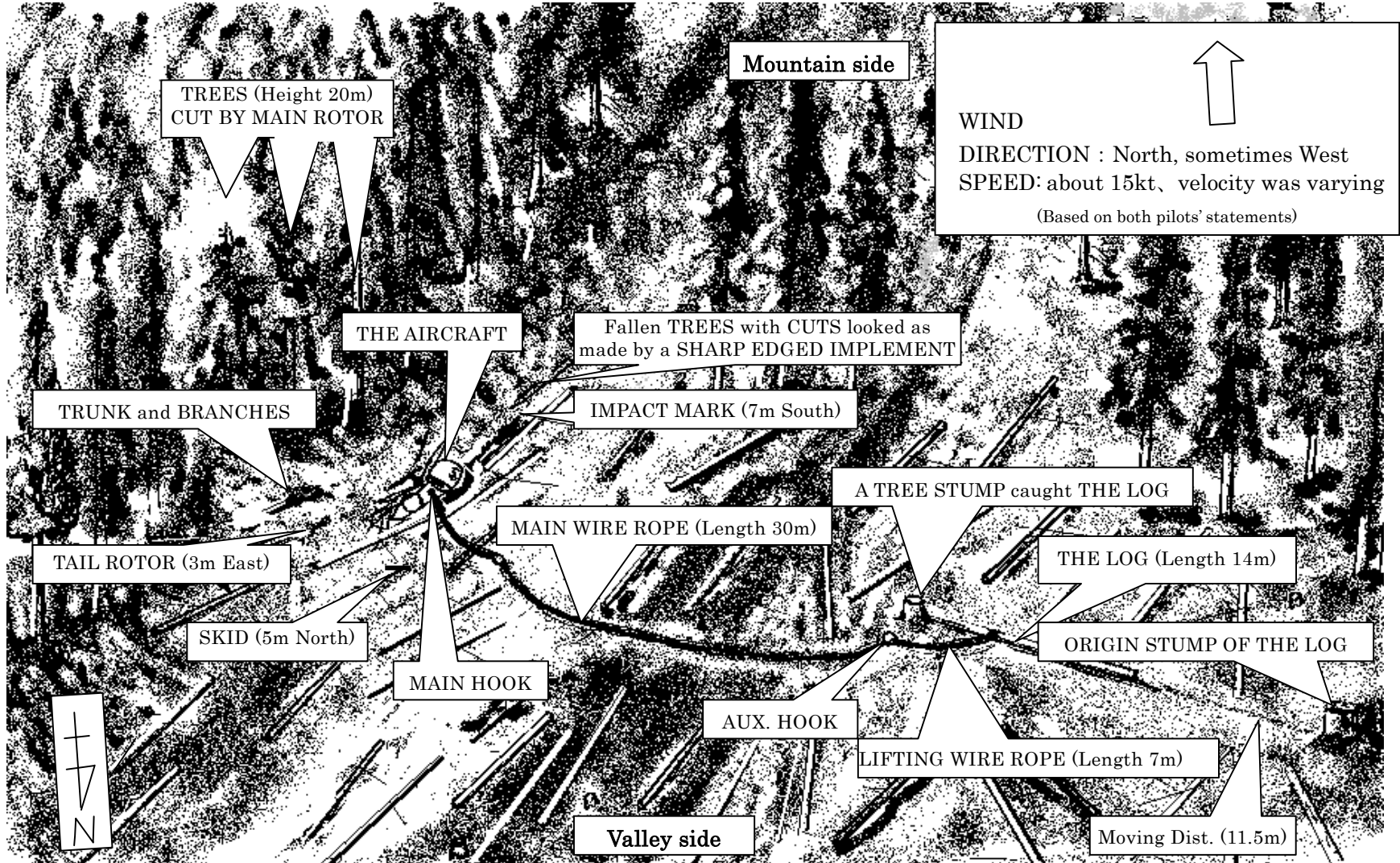

Figure 4-1 PRESUMED ACCIDENT

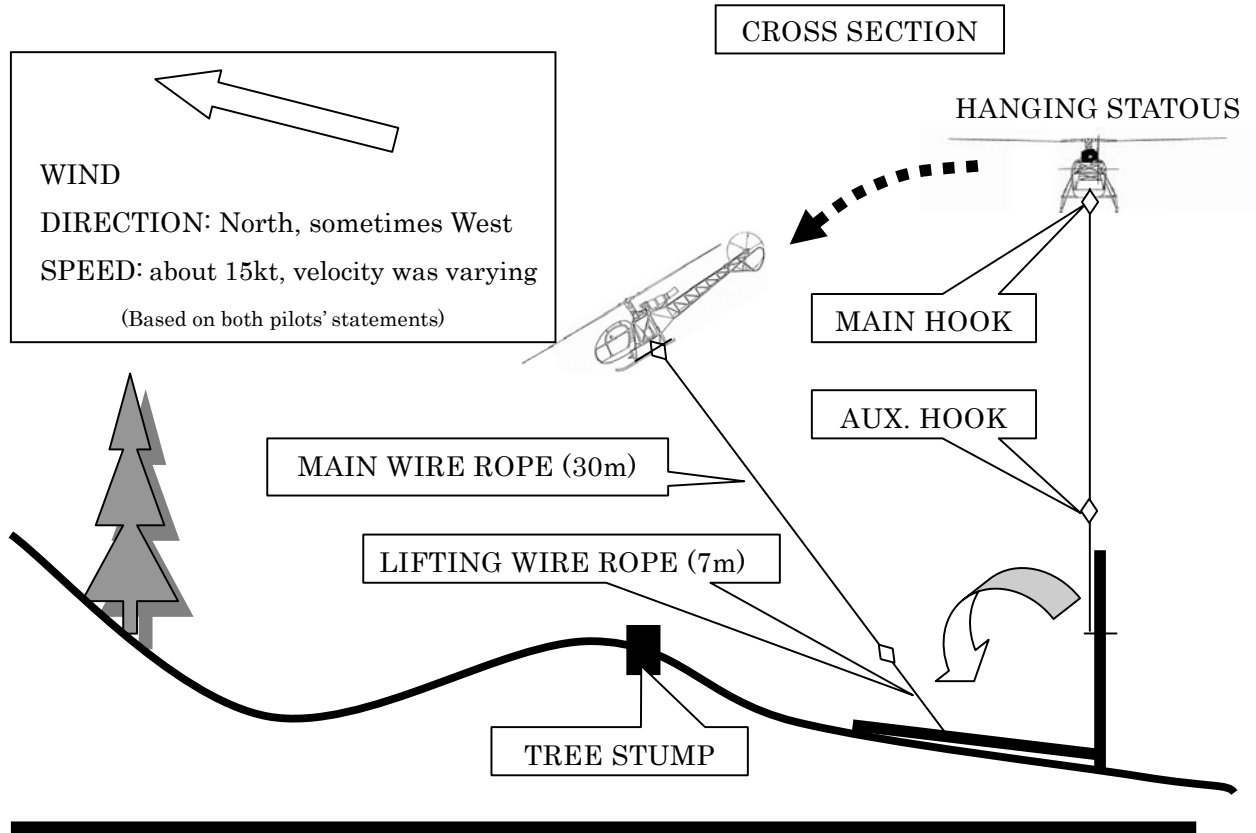
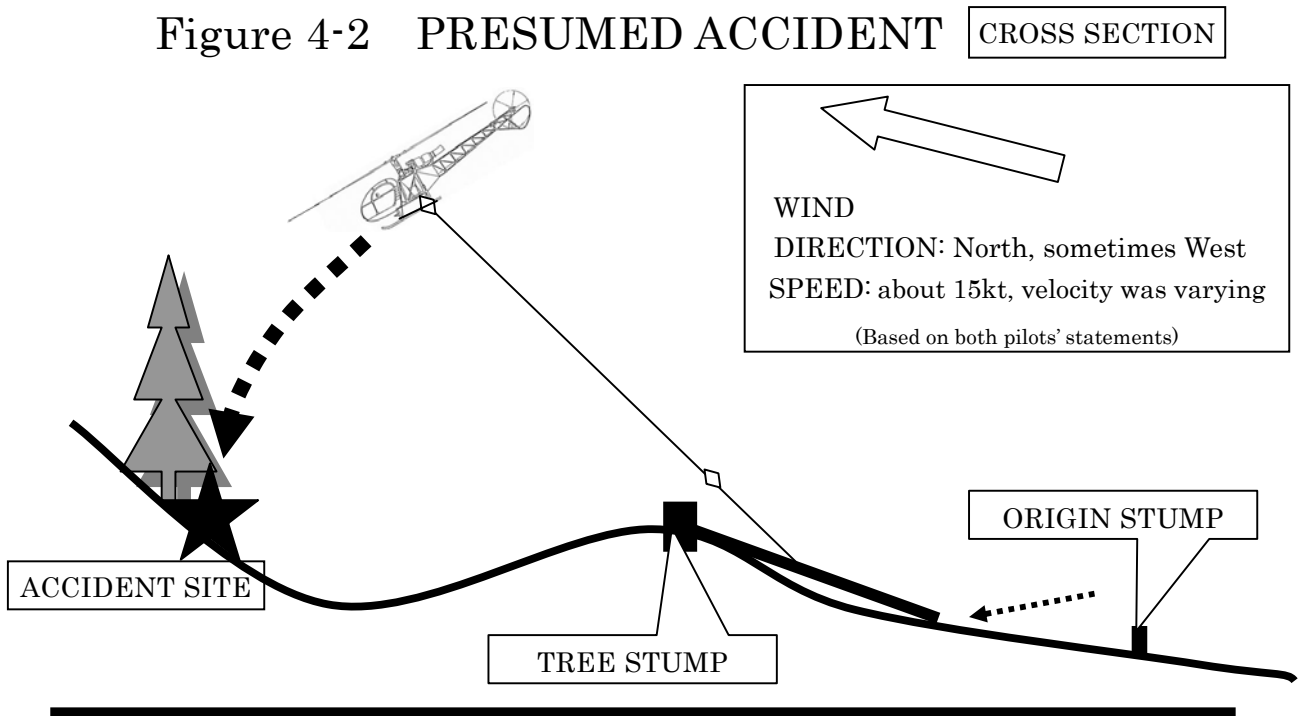
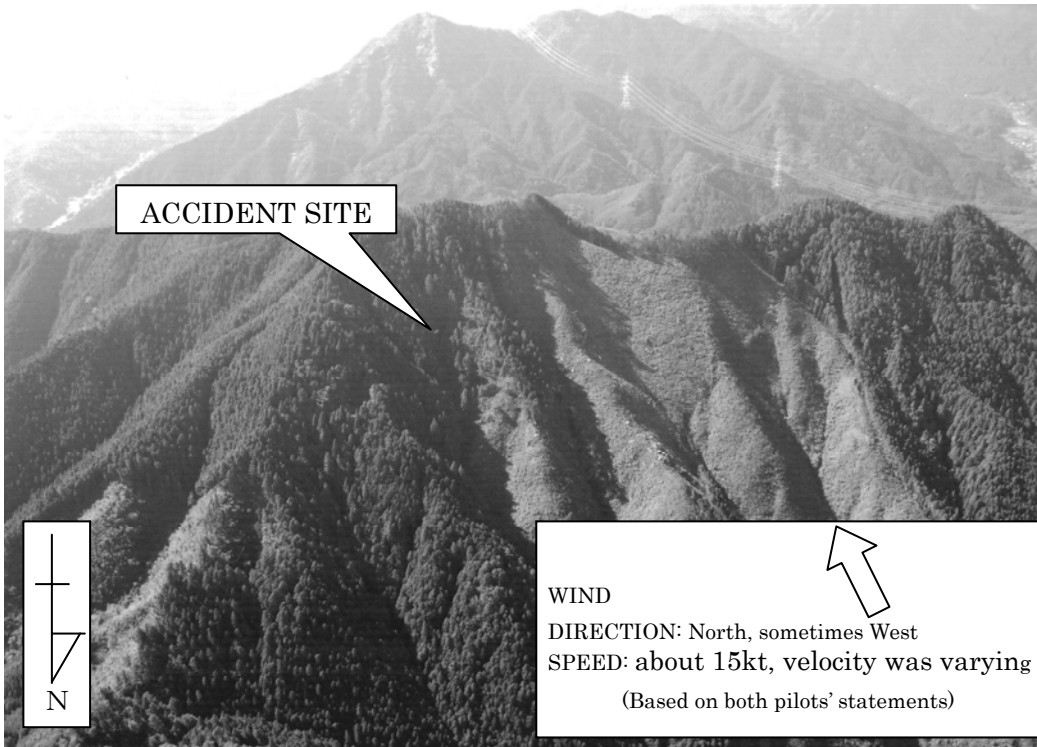

Figure 4-2 PRESUMED ACCIDENT



Photograph 1 ACCIDENT SITE



Photograph 2 THE AIRCRAFT

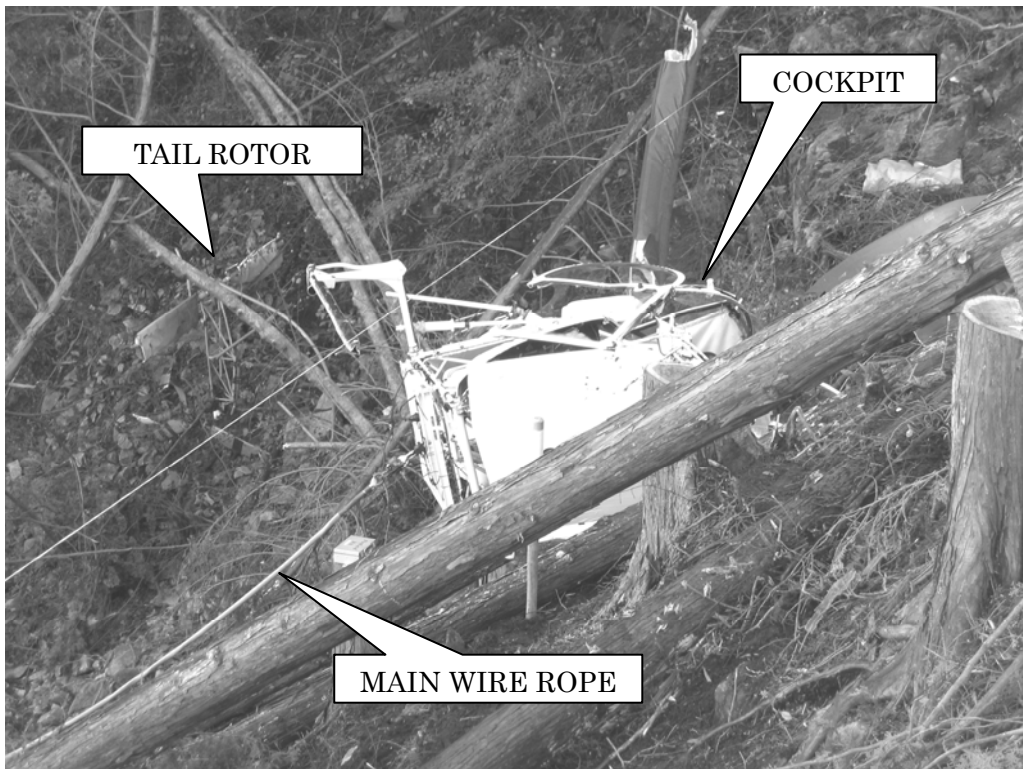

Photograph 3 ORIGIN STUMP OF THE LOG

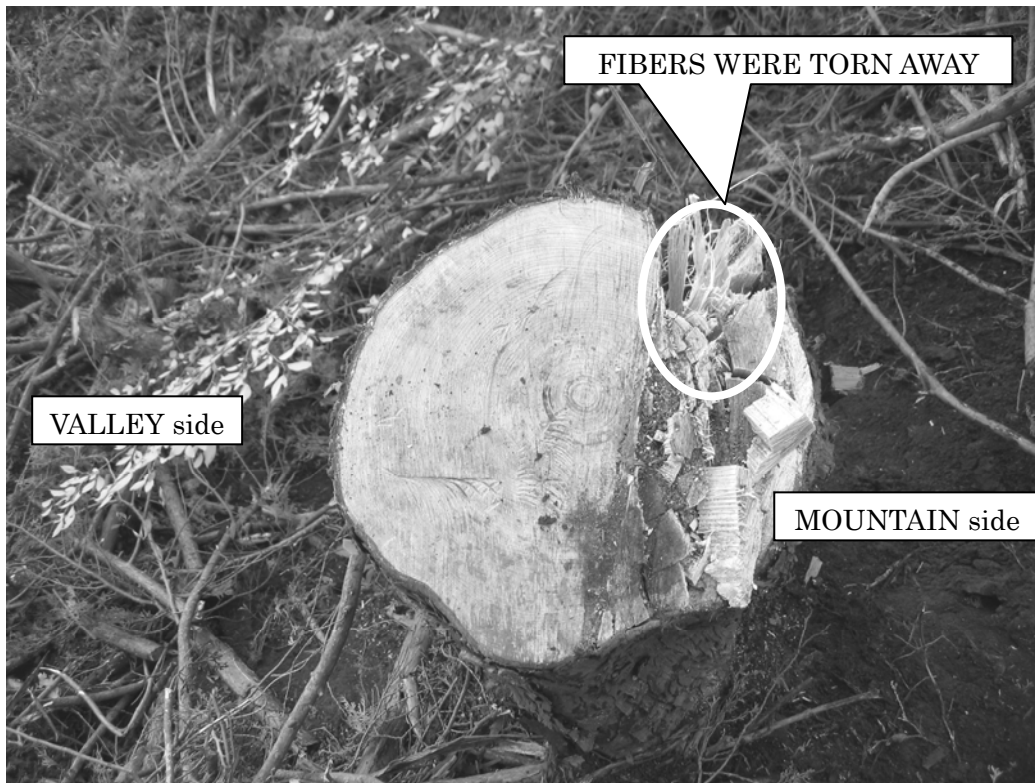

Photograph 4 A TREE STUMP CAUGHT THE LOG

