

AI2013-3

**AIRCRAFT SERIOUS INCIDENT  
INVESTIGATION REPORT**

**ACADEMIC CORPORATE BODY HIRATAGAKUEN  
J A 1 3 5 E**

September 27, 2013



The objective of the investigation conducted by the Japan Transport Safety Board in accordance with the Act for Establishment of the Japan Transport Safety Board (and with Annex 13 to the Convention on International Civil Aviation) is to prevent future accidents and incidents. It is not the purpose of the investigation to apportion blame or liability.

Norihiro Goto  
Chairman,  
Japan Transport Safety Board

Note:

This report is a translation of the Japanese original investigation report. The text in Japanese shall prevail in the interpretation of the report.

# AIRCRAFT SERIOUS INCIDENT INVESTIGATION REPORT

ENGINE DAMAGE  
TO  
A EUROCOPTER EC135T2 (ROTORCRAFT), JA135E  
OPERATED BY  
ACADEMIC CORPORATE BODY HIRATAGAKUEN  
OVER  
THE SEA ABOUT 6 NM (ABOUT 11 KM) NORTHWEST  
OF KERAMA ISLANDS, OKINAWA PREFECTURE  
AT  
10:20, MARCH 28, 2009

August 23, 2013

Adopted by the Japan Transport Safety Board

Chairman	Norihiro Goto
Member	Shinsuke Endoh
Member	Toshiyuki Ishikawa
Member	Sadao Tamura
Member	Yuki Shuto
Member	Keiji Tanaka

# SYNOPSIS

## <Summary of the Serious Incident>

A Eurocopter EC135T2, registration JA135E, operated by academic corporate body HIRATAGAKUEN, took off from Kumejima Helipad at 10:07 local time\*<sup>1</sup> on March 28, 2009 for emergency patient transportation. When the helicopter was flying over the sea en route to Shuri Helipad on the main island of Okinawa, its left engine stopped around 10:20 at about 800 ft (about 240 m) about 6 nm (about 11 km) northwest of the Kerama Islands. It changed the destination to Naha Airport and landed there at 10:46.

There were six persons on board, consisting of the pilot in command (PIC) and a mechanic, a doctor and a nurse as medical personnel, and an emergency patient and an attendant, but no one was injured.

The inside of the left engine of the helicopter was destroyed, but there was no outbreak of fire.

## <Probable Causes>

It is very likely that in this serious incident, the clogged injectors located relatively lower part of the left engine combustion chamber caused uneven fuel injection and combustion limited in the upper part, lead to a heat concentration to the Upper Structure resulting in engine interior damage.

Sea salt accumulation on fungicide with increased viscosity by heat probably clogged the fuel nozzles. Improper use of fungicide is probable. The JTSB could not determine the route of the sea salt penetration.

## <Safety Recommendations>

In view of the result of this serious incident investigation, the JTSB recommends the European Aviation Safety Agency (EASA) should take the following measures:

It is recommended that the European Safety Agency directs Eurocopter and Turbomeca to cooperatively study the helicopter operational environment and the effects of fungicide to inform helicopter customers of the proper dosing instructions and precautions.

---

\*<sup>1</sup> Japan Standard Time (TST): UTC+9hr. Unless otherwise stated all times are indicated in JST based on a 24-hour clock

Abbreviations used in this report are as follows:

AMM: Aircraft Maintenance Manual  
BEA: Bureau d' Enquetes et d' Analyses  
EASA: European Aviation Safety Agency  
EMM: Engine Maintenance Manual  
FLI: First Limit Indicator  
RFM: Rotorcraft Flight Manual  
TOT: Turbine Outlet Temperature  
TRQ: Torque  
VFR: Visual Flight Rules

#### Unit Conversion Table

1 ft:	0.3048 m
1 nm:	1,852 m
1 $\mu\text{m}$ :	$10^{-6}$ m
1 Gal (UK):	4.546 $\ell$
1 ppm:	0.0001 %

# 1. PROCESS AND PROGRESS OF THE INVESTIGATION

## 1.1 Summary of the Serious Incident

The occurrence covered by this report falls under the category of “Damage of engine (limited to major damage which occurred inside the engine) as stipulated in Article 166, Paragraph 4,Item 6 of the Ordinance for Enforcement of the Civil Aeronautics Act of Japan and is classified as an aircraft serious incident.

The Eurocopter EC135T2, registered JA135E, operated by academic corporate body HIRATAGAKUEN took off from Kumejima Helipad at 10:07 on March 28, 2009 for emergency patient transportation. When it was flying over water en route to Shuri Helipad on the main island of Okinawa, its left engine stopped around 10:20 at about 800 ft (about 240 m) about 6 nm (about 11 km) northwest of the Kerama Islands. It changed the destination to Naha Airport and landed there at 10:46.

There were six persons on board, consisting of the PIC and a mechanic, a doctor and a nurse as medical personnel, and an emergency patient and an attendant, but no one was injured.

The inside of the left engine of the helicopter was destroyed, but there was no outbreak of fire.

## 1.2 Outline of the Incident Investigation

### 1.2.1 Investigation Organization

On March 28, 2009, the JTSB designated an investigator-in-charge and another investigator to investigate this serious incident.

### 1.2.2 Representatives of the Relevant States

Accredited representatives of Germany and France, the former as the State of Design and Manufacture of the helicopter, and the latter as the State of Design and Manufacture of the engines, participated in this investigation.

### 1.2.3 Implementation of the Investigation

March 29 to 31, 2009	Helicopter examination and interviews
April 6 to 7, 2009	Helicopter examination
April 6 to June 30, 2009	Fuel examination
June 2 to 4, 2009	Engine teardown inspection
July 1 to 31, 2009	Helicopter and fuel examinations
September 17,2009	Helicopter examination
September 18 to October 30, 2009	Filter and fungicide examinations
September 29, 2009	Interviews
November 13, 2009	Interviews
December 11, 2009	Interviews
December 22, 2009	Fungicide examination
December 28, 2009	Interviews
March 15, 2010	Interviews
March 17 to 31, 2010	Examination of engine cleaning water
April 1, 13, and 16, 2010	Interviews

October 20 to December 28, 2010	Examination of fuel system components
December 28, 2010	Interviews
February 18 to March 31, 2011	Examinations of substances left in the fuel system components and fungicide
April 13, 2011	Examination of cut injectors
May 16, 2011	Examination of the injector interior
May 30 to June 7, 2011	Examination of sedimentation process of fungicide and salt in fuel

#### **1.2.4 Interim Report**

On July 30, 2010, the interim report based on the fact-finding investigation up to that date was submitted to the Minister of Land, Infrastructure, Transport and Tourism.

#### **1.2.5 Comments from Parties Relevant to the Cause of the Serious Incident**

Comments were invited from parties relevant to the cause of the serious incident.

#### **1.2.6 Comments from the Relevant States**

Comments on the draft final report were invited from the relevant States.

## 2. FACTUAL INFORMATION

### 2.1 History of the Flight

On March 28, 2009, the Eurocopter EC135T2, registered JA135E, operated by an Aviation Operation Division\*2, academic corporate body HIRATAGAKUEN (hereinafter referred to as “the Academic Corporate Body”), took off from Yomitan Heliport at 09:12 for emergency patient transportation to the main island of Okinawa responding to a request from a hospital on Kumejima Island, with a PIC sitting in the right pilot seat, a mechanic in the left pilot seat, a doctor and a nurse in rear seats. It landed at Kumejima Helipad at 09:40.

After boarding an emergency patient and an attendant the helicopter it took off from Kumejima Helipad at 10:07.

The outline of the flight plan for the Helicopter was as follows:

Flight rules:	Visual flight rules (VFR)
Departure aerodrome:	Kumejima Helipad
Estimated off-block time:	09:55
Cruising speed:	120 kt
Cruising altitude:	VFR
Route:	Zamami
Destination aerodrome:	Shuri Helipad
Estimated elapsed time:	0 hr 45 min
Fuel load expressed in endurance:	1 hr 50 min

The history of the flight up to the occurrence is summarized as below, based on the statements of the PIC, the mechanic and an air traffic controller at Naha Airport (hereinafter referred to as "the Controller"), who received an emergency report from the helicopter.

#### (1) PIC

Upon receiving a request from the hospital for emergency patient transportation, the PIC left Yomitan Heliport at 09:12 and the Helicopter landed at Kumejima Helipad within the hospital compound at 09:40. When he stopped the engines, the doctor, the nurse and the mechanic went to the hospital building to pick up the patient. When they all boarded the helicopter, it took off from Kumejima Helipad at 10:07. At 10:16, when the Helicopter was flying at about 1,000 ft at

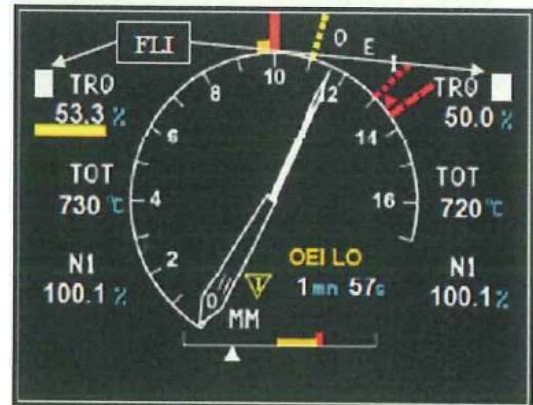

Figure: Example of Indication of Engine Instruments of the Helicopter

The values of the TQR, TOT and NI for the left and right engines are indicated on the corresponding side of the display.

“■” (FLI) emerges near the parameter whose value is nearing the operating limitation, attracting the pilot’s attention to the parameter.

\*2 The division operates the helicopter for emergency medical service (EMS).



about 130 kt, the first limit indicator (FLI) (See the explanation on the right) for right engine torque (TRQ) and turbine outlet temperature (TOT) began to blink alternately. The PIC and the mechanic confirmed the engine instruments together. But because all instrument indications were within the normal range, they concluded that it was an instrument error. After a little while, the TOT on the left engine instrument rose to 880 °C, slightly exceeding the limit value of 879 °C for the maximum continuous power. The PIC slightly reduced the power at mechanic's request.

Later, the PIC descended its altitude to 800 ft and decelerated to 100 kt to avoid clouds ahead. After a while, the left engine came to a shutdown. At that time, the helicopter was about 6 nm northwest of the Kerama Islands (about 27 nm west of Naha Airport) and the time was 10:20. The PIC tried to restart the engine, but to no avail with no response. Therefore, he performed an engine shutdown procedure. The indications on the right engine instrument were normal, and the helicopter was able to maintain a level flight. The PIC had an option to land at Kerama Airport, but because of his mission and the deteriorating weather, he decided to fly to the main island of Okinawa considering the alternate transportation means and easy transfer of the patient to a medical facility. Because the flight route was dotted with small islands toward the main island, the PIC told the doctor and the nurse that they would land on a small island nearby in case of abnormal indication of the right engine on the instrument and then, he changed the direction to Naha Airport.

The PIC declared an emergency and asked the controller to arrange for an ambulance for the transportation of the patient. At 10:46, the Helicopter landed on the Naha Airport taxiway and handed the patient to the ambulance standing by there.

(2) Mechanic

Shortly after the helicopter took off from Kumejima Helipad, the mechanic found that the right engine FLI was blinking alternately for the TRQ and the TOT. When the mechanic was wondering what was going on, a similar phenomenon occurred for the left engine FLI indication. The TOT rose to show a yellow underline indicating that the value surpassed the maximum continuous power limit, he asked the PIC to reduce the engine power. The engine conditions worried the mechanic and he jotted down the engine parameters for both engines. The TRQ values for both engines were equal at 47.5 %, while the left TOT was 865 °C and the right TOT was 795 °C. The left N1 (the compressor rotating speed) was 88.9 %, while the right N1 89.6 %. The outside air temperature was 19.8 °C. There were no major differences in the values for the two engines, except for the TOTs. Sometime later, the left engine TOT quickly rose and the left engine stopped.

Right engine parameters remained within normal range with slightly high TOT until the helicopter arrival at Naha Airport.

(3) Controller

At 10:25, the helicopter declared an emergency. When the Controller confirmed the situation, the helicopter requested an emergency landing at the airport because its left engine stopped while it was transporting an emergency patient. It was flying about 22 nm west of the airport at about 800 ft. The Controller instructed the helicopter to land on the taxiway, to restrict its influence on the operation of the Naha airport.

This serious incident occurred at about 10:20 on March 28, 2009, at about 800 ft about 6 nm northwest of the Kerama Islands (near a point Latitude 26° 16' N, Longitude 127° 10' E).

(See Figure 1: Estimated Flight Route, Photo 2: Display Example of Engine Instrument)

## 2.2 Injuries to Persons

There were no injuries.

## 2.3 Information about Damage to the Helicopter

The interior of the left engine was destroyed.

(See Photo 3: Left Engine Interior Damage)

## 2.4 Personnel Information

PIC (Male, Age 58)

Commercial Pilot Certificate (Rotorcraft)

Rating for multi-turbine engine (land): August 7, 1992

Class 1 Aviation Medical Certificate:

Validity: until November 30, 2009

Total flight time: 9,746 hr 11 min

Flight time in the last 30 days: 20 hr 49 min

Total flight time on the type of helicopter: 316 hr 12 min

Flight time in the last 30 days on the type of helicopter: 20 hr 49 min

## 2.5 Aircraft Information

### 2.5.1 Aircraft

Type: Eurocopter EC135T2

Serial number: 0443

Date of manufacture: November 23, 2005

Certificate of airworthiness: *DAF-20-356*

Validity: until October 18, 2009

Category of airworthiness: Rotorcraft, Normal N

Total flight time: 841 hr 18 min

Total cycles: 2,521

Flight time since last periodical check (100 hr check on January 8, 2009):  
58 hr 19 min

(See Figure 2: Three angle view of Eurocopter EC135T2, Photo 1: Serious Incident Aircraft)

### 2.5.2 Engines

(1) Left engine

Type: Turbomeca ARRIUS2B2

Serial number: 32225

Date of manufacture: July 21, 2005

Total time of usage: 841 hr 18 min

(2) Right engine

Type:	Turbomeca ARRIUS2B2
Serial number:	32226
Date of manufacture:	July 28, 2005
Total time of usage:	841 hr 18 min

### 2.5.3 Weight and Balance

When this serious incident occurred, the helicopter's weight was estimated to have been 2,625 kg and the center of gravity (CG) was estimated to have been longitudinally 4,298 mm aft of the datum and laterally 1 mm left of the airframe symmetry plane, both of which were estimated to have been within the allowable ranges (maximum takeoff weight of 2,835 kg and the CG range for the weight at the time of the serious incident: longitudinally 4,215 to 4,415 mm aft of the datum and laterally from 100 mm to the left to 100mm to the right).

### 2.5.4 Fuel and Lubricating Oil

Fuel onboard was Jet A-1 aviation fuel, and lubricating oil was Mobil Jet Oil II for jet engine.

## 2.6 Meteorological Information

### 2.6.1 General Weather Outlook

According to the surface analysis chart as of 09:00 on March 28, 2009, a low was in the southern part of the East China Sea, while a front was extending from the East China Sea to the Continent of China. According to the cloud imagery as of 10:30 on the same day, cloud areas accompanying the low and the front were seen broadly spreading from the Continent to the Okinawa region via the East China Sea, and the flight route of the helicopter was on the southern end of the cloud areas.

According to the radar echo intensity data as of 10:20, around the time when this serious incident occurred, there were precipitation areas around the flight route, and an area of strong precipitation was moving eastwardly toward the flight route.

### 2.6.2 Aeronautical Weather Observations

Aeronautical weather observations at Naha Airport around the time when this serious incident occurred were as follows:

10 : 53      Wind direction 160°, Wind velocity 12 kt, Visibility 10 km  
                  Shower rain  
                  Cloud: Amount 2/8, Type Cumulus, Cloud base 1,500 ft  
                                  Amount 5/8, Type Stratocumulus, Cloud base 4,500 ft  
                                  Amount 7/8, Type Altocumulus, Cloud base 7,000 ft  
                  Temperature 22°C, Dew point 19 °C  
                  Altimeter setting (QNH) 29.90 inHg

## 2.7 History of Engine Inspection and Maintenance

### 2.7.1 Engine Time Between Overhaul (TOB) and Engine Maintenance/Inspection at the Academic Corporate Body

According to a technical material issued by the engine manufacturer, the TOB for the engines involved is satisfied by 3,500 hours of operation or 15 years of duration, whichever comes first.

According to the engine flight log, the two engines were installed on the helicopter when it was manufactured. Their total time of use until the occurrence of this serious incident was 841 hr 18 min (the remaining time: about 2,658 hr) and their period of use was about three years and eight months (the remaining period: about 11 years and four months) – well before the TOB.

The helicopter maintenance records show that major maintenance work was done at the Academic Corporate Body's main maintenance base at Kobe Heliport. Inspection and maintenance which must be made with a frequency of every 200 hours or shorter (200 hr, 100 hr, 50 hr and 20 hr inspections), such as the engine power check and the lubricant oil system inspection, had been performed at Yomitan Heliport and other operation sites, in accordance with the engine maintenance manual (EMM) established by the engine manufacturer.

## **2.7.2 Latest Major Inspection and Maintenance Performed Before the Serious Incident**

The helicopter maintenance records show that an engine inspection and maintenance were done at the Academic Corporate Body's main maintenance base about seven months before (September 13, 2008) the serious incident. The 800-hour inspection and second 400-hour inspection after the manufacturing were done including borescope inspections for the engine interiors (400-hour inspection item) and new installation of the preference injector, fuel manifolds and fuel filters on either side of engine. These maintenance works found no anomalies. The post-maintenance engine run demonstrated normal values.

## **2.8 Operational History of the Helicopter**

### **2.8.1 Operational History at Yomitan Heliport**

According to the flight log for the helicopter, the Academic Corporate Body installed medical equipment on the helicopter about one year after its production. The helicopter was stationed alternately at Yomitan Heliport and at a hospital in Nagasaki Prefecture to fly EMS missions.

The operational history of the helicopter at Yomitan Heliport was summarized as below:

Number of tours:	Three
Total period:	530 days from March 2007 to March 2009
Flight time in total:	492 hr 05 min (about 59 % of total flight times)
Flight cycles in total:	1,421 (about 56 % of the total)
Average flight time:	About 21 minutes
Characteristics of flights:	Over-water flight between the Main Island and remote islands account for about 90 %. Its landing sites were mostly within 1 km from the coastlines.

## **2.8.2 History of Flight Operations after Replacement of Fuel System Components**

As described in 2.7.2, about seven months had elapsed before the incident from September 13, 2008, when both engines received the endoscope inspections with replacement of the fuel system components. The total flight time during the period was 154 hr 40 min and the flight cycles were 517.

After the fuel system component replacement the helicopter flew EMS missions for a hospital in Nagasaki Prefecture followed by the ferry to Yomitan Heliport via Kobe Heliport. The helicopter started EMS missions there on December 1, 2008. It took about four months before the occurrence of the serious incident. The flight time of the helicopter during the period was 91 hr 22 min with 271 flight cycles.

## **2.9 Daily Helicopter Operations at Yomitan Heliport**

### **2.9.1 Helicopter EMS Missions**

The EMS missions at Yomitan Heliport was summarized as below, according to the statements of the director of Yomitan Heliport, mechanics and hospital personnel.

Yomitan Heliport operational hour begins at 09:00 and ends at 17:00. Before the start of daily operations, the helicopter is towed out of the hangar followed by a pre-flight check including a check for water in the fuel tank. Then the helicopter remains parked on the helipad to respond to any request of transportation. The helicopter is loaded with about 330 kg of fuel (equals to about 423 ℓ accounting for about 60 % of the total fuel tank capacity of 710 ℓ) for a flight time of 1 hr and 40 min to cover a shuttle flight between the heliport and remote islands.

The helicopter flies at 1,000 ft or below not to expose patients to big difference of atmospheric pressure. It takes about 10 min for ground reception and release of patients. The helicopter always stops its engines after landing. Upon completing a mission, it immediately returns to Yomitan Heliport to stand by for the next mission. The helicopter starts and stops its engines three times per mission.

The engine conditions are monitored every day and the 100 hr engine inspection done in February 2009 found no anomalies.

Frequent over-water flying and the proximity of Yomitan Heliport to the sea required post-flight engine compressor cleaning to wash down the accumulated floating sea salt particles\*<sup>3</sup> with water. When salt accumulation was found on the helicopter skin, the helicopter surface was rinsed with fresh water from water purifier. The helicopter was stored in the hangar with the doors shut after the end of the operational hours.

### **2.9.2 Facility and Stored Fuel**

Yomitan Heliport is located on the western coast in the central part of the main island of Okinawa. It sits about 50 m away from the sea shore and it includes an office, a helipad, a hangar and a fuel storage facility.

Fuel at the facility is stored in metallic drums with a capacity of about 200 ℓ. Opened drums and fresh ones are separated. A drum is sealed with screwed plugs. An inventory record showed that 10 new drums (about 2,000 ℓ in total) were brought in every nine days on average.

---

\*<sup>3</sup> The sea salt particles are microparticles of salt as small as 3 to 18µm, which are emitted into the atmosphere following the rupture of sea water bubbles which emerge on the sea surface mainly due to sea water splashes

### 2.9.3 Servicing Procedures

Several mechanics stated the servicing procedures at the heliport as follows.

The helicopter was usually refueled after the end of its daily flights. When it flew more than once, it was refueled as the need arises. Average refueling quantity was about one and a half drums (about 300 ℓ). When a fresh drum was opened, mechanics did a visual check of the content and tested it for water deposit. Then they added fungicide into the fuel, stirred it and fed it to the aircraft with an electric fuel pump.

Visual checks had found small foreign objects in the fuel several times before the occurrence of this serious incident. When large amount of foreign objects were found, the fuel drum involved was not used.

They checked for water deposit by applying paste-type water detecting agent on the tip of a testing stick and stirred the fuel with it. No water had been detected in the fuel. (See Photo 6: Bird's-eye View of Yomitan Heliport)

### 2.10 Fungicide (KATHON FP 1.5) Used at Yomitan Heliport

Couples of mechanics stated why and how they used fungicide at Yomitan Heliport. The statements are summarized as below.

During the course of a helicopter operation, it began to get mildewed on its fuel filter support. As a countermeasure they started to add the EMM-approved fungicide in the fuel drum on and after December 1, 2008. But in-house instruction about the fungicide was not precise before the occurrence of this serious incident. Therefore, not all fuel drums were dosed with fungicide. Although the EMM specified to add the fungicide with a concentration of 100 ppm (20 ml of the fungicide for 200 ℓ of fuel), there was the possibility of mechanics' erroneous calculation. Furthermore there were no records about the amount of the fungicide actually added to the fuel.

The fungicide used at Yomitan Heliport was KATHON FP 1.5, a product of Fuel Quality Service, Inc. of the United States of America. The fungicide is contained in a container of 1UK gal (4.55 ℓ). The container carried a list of ingredients and handling remarks, but not the remarks on the usage or dosage.

The manufacture's document included the following description about the usage.

(Excerpt)

*Kathon<sup>TM</sup> FP 1.5 Microbicide is effective and economic to use and begins working within 5 hours. However, preferred soak time is 12-24 hours.*

### 2.11 Descriptions on Fungicide in Manuals

The TC data sheet (a document of design specifications) prepared by the European Aviation Safety Agency (EASA) which had authorized the helicopter design, calls for referring to the EASA authorized rotorcraft flight manual (RFM) to find approved fuel, lubricant oil and fungicide. But descriptions about fungicide were not in the RFM. There were no descriptions about the use of fungicide, either, in the aircraft flight manual (AFM) and the aircraft maintenance manual (AMM).

However, the engine maintenance manual (EMM) for the helicopter had descriptions as mentioned below about fungicide usage, separately showing dosage for preventive

treatment and curative treatment. The phrase “Refer to the conditions given in the Maintenance Manual” comes at the top of the paragraph “4 Fungicide Additive” shown below, had no corresponding description in the AMM as described above.

*TURBOSHAFT ENGINE ARRIUS 2B2 MAINTENANCE MANUAL*

(Excerpts from related clauses are shown below, with applicable remarks underlined.)

*71 POWER PLANT*

*71-00-02 FUEL/LUBRICANTS/SPECIAL PRODUCTS-GENERAL*

- Omitted -

*2 Fuels-Lubricants-Special products-General*

- Omitted -

(c) Approved fuel additives

- Omitted -

4 Fungicide additives

Refer to the conditions given in the Maintenance Manual.

- Omitted -

KATHON FP 1.5

- Preventive treatment: 50ppm

- Curative treatment: 100ppm

## **2.12 Test and Research**

### **2.12.1 Examination of the Engine Interior**

Both engines were shipped to Turbomeca, the manufacturer in France for teardown inspection with the oversight of French accident investigation authority (hereinafter referred to as “BEA”). The inspection found the following engine interior conditions.

(1) Left engine interior

- a. The upper part of the inner wall of the combustion chamber (viewed from the front and the top is aligned to 12 o'clock) was discolored black in an area from 10 to 4 o'clock (hereinafter referred to as “the Upper Structure”), showing signs of uneven combustion.
- b. The high pressure (HP) nozzle guide vanes for smoothing the flow of combustion gas was discolored due to overheating toward the Upper Structure and the rear edges of the guide vanes were damaged.
- c. All the HP turbine blades, which rotate the compressor, were fractured from the middle section, while the turbine ring and the rear bearing support, which form the flow path of combustion gas was damaged toward the Upper Structure.
- d. The pressure turbine (PT) nozzle guide vanes were damaged toward the Upper Structure, while all the blades of power turbine were fractured.
- e. The exhaust diffuser and its struts were fractured toward the Upper Structure, and the fractured sections were melted.

(2) Right engine interior

The rear edge of three HP nozzle guide vane had heat damages, but there was

no major damage to the interior structure.

(3) Left engine fuel system components

Accumulated white and brown foreign substances covered all of the 10 fuel injector outlets. A fuel flow test confirmed that five of them (No. 3 to No. 7) were clogged and one (No. 9 injector) demonstrated insufficient amount of flow. Accumulated foreign material was found near the inlet of the fuel filter upstream of fuel manifold.

(4) Right engine fuel system components

Like the left engine, accumulated foreign substances covered all of the 10 fuel injector outlets. A fuel flow test confirmed that four of them (No. 3 to No.) were clogged and the three (No. 2, 9 and 10 injectors) demonstrated insufficient amount of flow. Accumulated foreign material was found near the inlet of the fuel filter.

(See Figure 3: The Structure of the Engine and Main Sections Damaged in the Left Engine Inside, Photo 4: Left Engine Interior Damage, Photo 5: Contaminated Fuel System Components)

### **2.12.2 Examination of Engine Fuel System Components**

Engine system components (injectors and fuel filters) for both engines and fuel on board fuel sample were shipped to the BEA for examination. The summary of the examination are as follows:

(1) Injectors

Most of the injector heads were covered with foreign substances and fuel nozzles of the left and right injectors were clogged entirely or partially. Main ingredients of the substances were chlorine and sodium, in a form of crystallized sodium chloride.

(2) Fuel Filters

About half of the surface of the left and right fuel filters was covered with sodium chloride.

(3) Fuel

The sample proved to be Jet A-1 aviation fuel with no traces of salt. Salt is not fuel-soluble, but it can be water-soluble with the presence of water in the fuel.

(See Photo 5: Contaminated Fuel System Components)

### **2.12.3 Fuel Quality Loaded on the Helicopter**

After this serious incident, fuel sample from the helicopter was analyzed. The sample proved to be Jet A-1 aviation fuel satisfying the fuel specification with no traces of salt.

### **2.12.4 Detailed Examination of Fuel Drums and Foreign Substances in Fuel**

As described in 2.9.3 the foreign objects in the fuel drums stored at Yomitan Heliport had been known even before the occurrence of this serious incident.

The detailed examination found three kinds of foreign substances in several unused Fuel Drums: filaments, small thin sheets and translucent films. The result of the detailed examination was as follows:

(1) Main ingredient of the filaments was iron. In view of their shapes, they were



found to be broken pieces of screw threads of the flanges or the plug screws.

- (2) A component analysis revealed that the small thin sheet was a piece of inner wall coating for the drum.
- (3) As a result of the comparative analysis with the inner wall substance, the translucent film was found to have the same contents as that of the small thin sheet.

An infrared (IR) absorption spectrum analysis of the transparent liquid deposited at the bottom of the fuel drums in use revealed that the resultant absorption signature was identical to that of the fungicide.

Quality checks for all the fuel remained, including fungicide-dosed one and contaminated one with metallic pieces, revealed no quality deficiencies.

(See Photo 7: Transparent Liquid Taken From a Fuel Drum in Use)

#### **2.12.5 Examination of Electric Fuel Pump**

As described in 2.9.3, the helicopter was serviced at Yomitan Heliport with an electric fuel pump. The filter of this pump (hereinafter referred to as “the Pump Filter”) was replaced with a new one in March 2008, about one year before this serious incident.

The Pump Filter is a sheet of silicon-coated paper. Many foreign objects were trapped on the inlet side of filter surface. The analysis revealed that they were metallic pieces having their origins in the fuel drums. No fungicide ingredients were detected.

#### **2.12.6 Fungicide Dissolution in the Fuel**

An amount of the fungicide, which creates a concentration of 50 ppm as specified in the EMM, was added to 10 l of fuel in a transparent container, stirred and left as it was for observation. After the stirring the fungicide became invisible dissolving into the fuel. After about 20 min of stationary condition, transparent substance precipitated at the bottom of the container. The condition of the mixture was observed for seven days stirring it once a day, but the precipitated transparent substance remained on the bottom.

The substance was put to an IR absorption spectrum analysis. The analysis revealed that the absorption peaks were consistent with that of the fungicide.

(See Photo 8: Fungicide Dissolution in the Fuel)

#### **2.12.7 Examination of Fungicide Permeation Through the Pump Filter**

When the fungicide alone was poured onto the filter set on the filter holder, it did not permeate through the filter. Then the fuel was added onto it and stirred, the mixture permeated through the filter and dropped into a flask placed below. The mixture in the flask was poured into another flask and was left stationary. The fungicide precipitated at the bottom of the flask.

(See Photo 9: Permeation of the Fungicide Through the Pump Filter)

#### **2.12.8 Transformation of the Heated Fungicide**

As the fungicide-dosed fuel is sprayed into the engine combustion chamber through hot injectors, heat influence on the fungicide was observed. When the fungicide in a beaker was heated, its viscosity gradually increased. When the applied temperature exceeded 200 °C, the fungicide transformed into dark brownish gum on the bottom.

(See Photo 10: Transformation of the Heated Fungicide)

### **2.12.9 Reexamination of Injectors**

The injectors and the fuel filters installed on both engines were shipped back from BEA. The JTSB did a teardown inspection of them to study sediment distribution in the fuel flow path.

#### **(1) Sediments on Injectors**

An analysis confirmed the presence of chlorine, sodium, magnesium, potassium and calcium, being consistent with the ingredients of the sea salt. Trace of viscous sulfur was also detected.

The fuel and the fungicide additive were separately heated and their residues were analyzed. The fuel residues contained no sulfur; the fungicide residues did.

#### **(2) Sediment Distribution**

Sediments were exclusively found near the inside of the fuel nozzles of the injectors.

### **2.13 Post-Serious-Incident Fuel System Follow-Up**

The Academic Corporate Body resumed EMHS at Yomitan Heliport after installing spare engines on the helicopter without using the fungicide additive. Its fuel system was checked around 50 and 100 flight hours after resuming the service. The checks revealed as follows:

#### **(1) The check after 58 flight hours (at Yomitan Heliport, on July 1, 2009)**

- a. The visual inspection of fuel injectors removed from both engines under magnifier found no anomalies. No foreign substance had accumulated on the injectors. Each nozzle was clean and had no indication of clogging.
- b. An analysis of a liquid sample taken from the drain port at the bottom of the fuel tank revealed that it was Jet A-1 aviation fuel meeting the fuel specifications. The analysis detected a water content of less than 0.01 %. This amount of water didn't precipitate in the fuel causing no problem without salt. No germs were detected in the fuel sample.

#### **(2) The check after 123 flight hours (at Kobe Airport, on September 17, 2009)**

- a. The fuel tank was emptied and residual fuel at the bottom of the tank was wiped off with absorbent paper to examine the residue at the bottom. No metal fragments or crystallized salt were found. An infrared absorption spectrum analysis of the residual fuel absorbed in the paper detected no ingredients of the fungicide.
- b. The examination of screened objects on the engine fuel filters detected silicon, potassium, calcium and magnesium. Chlorine and sodium as main ingredients of sea salt were not detected.

### **2.14 Other Related Matters**

#### **2.14.1 Fuel Flow After the Engines Shutdown**

The engines are so designed that when the main engine switch is turned off, compressed air in the combustion chamber pushes fuel back to the tank to prevent fuel inside the injectors from being discharged into the atmosphere. But this does not mean

that the whole amount of fuel inside the injectors returns to the tank; some amount of fuel remains in the fuel flow path.

The fuel pump continues to work until the engine stops, and fuel remained in the fuel flow path is returned to the low-pressure fuel pump inlet. The fuel filters in the fuel flow path are filled with fuel regardless of fuel pump operation.

(See Figure 4: Fuel Flow at the Engine Start, Figure 5: Fuel Flow at the Engine Shutdown)

#### **2.14.2 Fuel Tank Air Vent**

The fuel tank has an air vent to equalize the interior pressure with the atmospheric pressure.

#### **2.14.3 Emergency Procedures for One Engine Operable in Flight Stipulated in the AFM**

A PIC shuts down the failed engine while flying the helicopter maintaining the one engine operable limit of the healthy engine. Although a PIC is required to land as soon as possible considering the situation, but a decision of where to land and whether to continue flying are left to the his discretion.

### **3. ANALYSIS**

#### **3.1 Airman Competence Certificate**

The PIC held a valid airman competence certificates and a valid aviation medical certificate.

#### **3.2 Airworthiness Certificate**

The helicopter had a valid airworthiness certificate and had been inspected and maintained as prescribed.

#### **3.3 Relations to Meteorological Conditions**

It is highly probable that the meteorological condition at the time had no bearing with this serious incident.

#### **3.4 Engine Interior**

##### **3.4.1 Left Engine Interior**

As described in 2.12.1 (1) and 2.12.1 (3), the hot section suffered the interior damage ranging from the HP nozzle guide vane to the exhaust diffuser. Among the rotating parts, turbine blades were fractured in full circumference, while other parts were heat-damaged toward the Upper Structure. Six of the 10 fuel manifold injectors were clogged or having insufficient fuel flow. The unclogged injectors accounted for those placed in the upper part of the combustion chamber, corresponding to the area of interior damage behind the combustion chamber.

It is highly probable that the interior damage developed as follows:

The accumulated material clogged six lower injectors allowing upper injectors to operate leading to overheated conditions in the upper interior, damaging the upper structure between the HP nozzle guide vanes and exhaust diffuser; this destruction resulted in fractures of downstream rotating parts – HP turbine blades and power turbine blades.

##### **3.4.2 Right Engine Interior**

As described in 2.12.1 (2) and 2.12.1 (4), the interior damage of the right engine was limited to a partial fracture of the HP nozzle guide vanes, but sediments were found in the fuel filters and several injectors. Like the left engine, the unclogged injectors were those placed in the upper area of the combustion chamber. As described in 2.7.1 and 2.7.2, both engines remained installed on the helicopter since its production. As the records of inspection and maintenance for the helicopter at the Academic Corporate Body and its operational history are consistent, it is probable that the condition of the right engine was in a process leading to the same kind of damage observed in the left engine.

#### **3.5 Reason Why the Fungicide Permeated Through the Pump Filter**

The fungicide in the fuel precipitated on the bottom of the container as transparent material not completely dissolving into the fuel when left as it was, and a detailed examination of the fuel drums made at Yomitan Heliport found foreign substances derived from the fuel drums and the precipitated fungicide on the bottom, which was added when

refueling. (The fungicide was added to the fuel drums even before the serious incident, but not to all the drums at the Heliport, with fluctuating amount of dosage.)

On the other hand, the pump filter is permeable to the fungicide-added fuel, and the fungicide-dosed fuel was fed into the tank immediately after putting fungicide into the fuel drum and stirring at the Heliport. The examination of the pump filter demonstrated that many metallic pieces and other substances derived from the fuel drums were trapped on the filter surface, but not the ingredients of the fungicide.

Given these facts, it is highly probable that the fungicide went through the fuel filter into the fuel tank.

### **3.6 Accumulated Substance on Fuel Filters and Injectors**

(1), (2), (3) and (4) mentioned below probably explain that the sediment on the fuel filters is sea salt, while the accumulated substances in the injectors are the fungicide and sea salt.

- (1) As described in 2.12.2 (1) and (2), the sediments in the fuel filters and the injectors were accumulated salt.
- (2) As described in 2.12.9 (1), the salt content of the fuel filter sediments is consistent with that of the sea salt.
- (3) As described in 2.12.8, the viscosity of the fungicide increases when heated. (The temperature of fuel near injectors increases not exceeding 150°C. The fungicide does not solidify but its viscosity was increased to a higher extent.)
- (4) As described in 2.12.9 (1), sulfur was detected from the sediment of the heated fungicide while viscous sulfur was detected from the injector residue.

As described in 2.13, both engines were replaced with new ones after the occurrence of this serious incident, and then, the Academic Corporate Body resumed EMHS. The helicopter operation and the circumstances remained unchanged between pre- and post-serious incident, except for the terminated use of the fungicide additive. As described in 2.13, the fuel system checks after the termination of the fungicide use revealed no sediments in the fuel filters and the injectors.

### **3.7 The Route of Sea Salt Contamination**

As described in 3.6, the sediments found in the fuel filters and the injectors were sea salt. As described in 2.14.1, the fuel filters are filled with fuel from the fuel tank regardless of fuel pump operation, while the fuel which goes through the fuel filters jets out from the injectors. Therefore, it is probable that sea salt which had got into the fuel tank was driven with the fuel and accumulated in the fuel filters and the injectors.

However, as described in 2.12.2 and 2.12.3, sea salt was not detected in the liquid taken from the fuel tank when it was examined in France and Japan. As described in 2.13, sea salt was not found in the follow-up observation, either. With these facts the JTSC could not determine the sea salt penetration route into the fuel tank.

On the other hand as described in 2.8 and 2.9, Yomitan Heliport, where the helicopter had been parked, is in an environment of floating sea salt particles. In addition, the helicopter flew close to the sea surface where salt particles float, with frequent engine shutdowns and restarts per day. As described in 2.14, at engine shutdown compressed air in the combustion chamber pushes fuel back to the tank to prevent fuel inside the injectors

from being discharged into the atmosphere. These facts suggest some possibility that some of sea salt particles in the outside air in the combustion chamber accumulated on the injectors.

### **3.8 Process of Injector Clogging**

As stated in 2.14.1, the fuel line is designed to push back remaining fuel in injectors to fuel tank when engine main switch is turned off. The design prevents excessive fuel from remaining in the fuel line. In case of fuel line contamination, fuel contamination and degraded injector decreases the push-back capability.

It is probable that fuel remaining in the fuel line (the one not being pushed back to the fuel tank) flowed into the lower injectors as the air pressure in the combustion chamber decreased, and as described in 2.12.8, sea salt accumulated on the fungicide whose viscosity was increased by being exposed to the heat from fuel injectors and surrounding parts.

Salt did not accumulate equally regardless of injector's location; the lower the injectors are, the more salt accumulation observed. This unequal accumulation was probably caused by gravity. There is also a possibility that differential pressures for fuel push-back were not necessarily equal due to clogged injectors

### **3.9 Detection of Signs for Engine Interior Damage**

As described in 2.7.1, the engines received an inspection and maintenance at the Academic Corporate Body in accordance with the engine manufacturer EMM. Both engines had not reached the TBO.

As described in 2.7.2, the sediment-affected injectors found in the engine teardown had been replaced about seven months before (September 13, 2008) the serious incident. Further, follow-on daily checks and 100 hr engine power checks recorded normal values. Therefore, it is probable that the fuel nozzles were completely or partially clogged after the use of the fungicide (December 1, 2008 or later). But, as described 2.9.1, the engine condition checks and engine performance showed no abnormalities until the serious incident. Therefore, it was probably difficult to detect signs of engine interior damage.

### **3.10 Inappropriate Use of Fungicide**

As described in 2.11, the RFM carried no descriptions about fungicide in the clause about fuel additives. But, as described in 2.10 and 2.11, the use of the fungicide involved had been authorized in the EMM for the helicopter. Therefore, it is highly probable that the Academic Corporate Body had started to use the fungicide. But no clear in-house instructions about the fungicide use as described in 2.10 suggests that the amount of use as prescribed in the EMM had not been observed and been used in a higher density than authorized.

These findings suggest that if the Academic Corporate Body had added prescribed amount of fungicide into the fuel drums as per the EMM, stirred the mixture, and refueled the helicopter after a lapse of sufficient time as described in 2.10, the fungicide had not acquired viscosity for sea salt accumulation leading to clogging of the fuel nozzles.

#### 4. PROBABLE CAUSES

It is very likely that in this serious incident, the clogged injectors located relatively lower part of the left engine combustion chamber caused uneven fuel injection and combustion limited in the upper part, lead to a heat concentration to the Upper Structure resulting in engine interior damage.

Sea salt accumulation on fungicide with increased viscosity by heat probably clogged the fuel nozzles. Improper use of fungicide is probable. The JTSCB could not determine the route of the sea salt penetration.

## **5. PREVENTIVE ACTIONS**

### **5.1 Preventive Actions Taken after the Occurrence of the Incident**

#### **5.1.1 Measures Taken by the Corporate Academic Body**

1. Fungicide use was terminated.
2. Engine air inlets and exhaust pipes are plugged with covers when the helicopter is housed in the hanger.
3. Engine compressors are cleaned by cranking the engines (with the starter on without ignition) with cleaning water dosed with a cleaning agent authorized in the EMM. In case of post-flight EET exceeding 70 °C, another compressor cleaning is required next morning.
4. In-flight engine conditions are monitored.
5. Fuel filters and engine interiors are inspected with an endoscope at shorter intervals than prescribed in the EMM.

#### **5.2 Preventive Actions to be Taken**

The use of fungicide for the same type of rotorcraft has not yet been described in the RFM and the AMM, but there are pertinent descriptions in the helicopter EMM. Therefore, when the helicopter and engine designer/manufacturer examine the use of the fungicide, both parties should, based on the findings of this investigation, cooperatively study the helicopter operational environment and the effects of fungicide to inform helicopter customers of the proper dosing instructions and precautions.



## 6. SAFETY RECOMMENDATIONS

In this serious incident a Eurocopter EC135T2, registered JA135E, operated by academic corporate body HIRATAGAKUEN, diverted to an aerodrome after the left engine shutdown during an emergency patient airlift.

Highly probable cause of the engine shutdown is that the clogging of injectors in the relatively lower part of the left engine combustion chamber left the fuel injection restricted to upper part, developing into a heat concentration in the Upper Structure damaging the engine interior.

Increased viscosity of the fungicide near the fuel nozzle clogged the injectors with sea salt.

Possible contributing factor is: a larger amount of the fungicide than authorized in the EMM (engine maintenance manual) for the same type of rotorcraft had been added to fuel drums, stirred, and the mixture was immediately supplied to the helicopter. The RFM (rotorcraft flight manual) for the same type of helicopter carries no descriptions about the use of fungicide in its authorized fuel additives.

In view of this serious incident investigation, the Japan Transport Safety Board recommends that the EASA should take the following measures:

It is recommended that the European Safety Agency directs Eurocopter and Turbomeca to cooperatively study the helicopter operational environment and the effects of fungicide to inform helicopter customers of the proper dosing instructions and precautions.

Figure 1: Estimated Flight Route

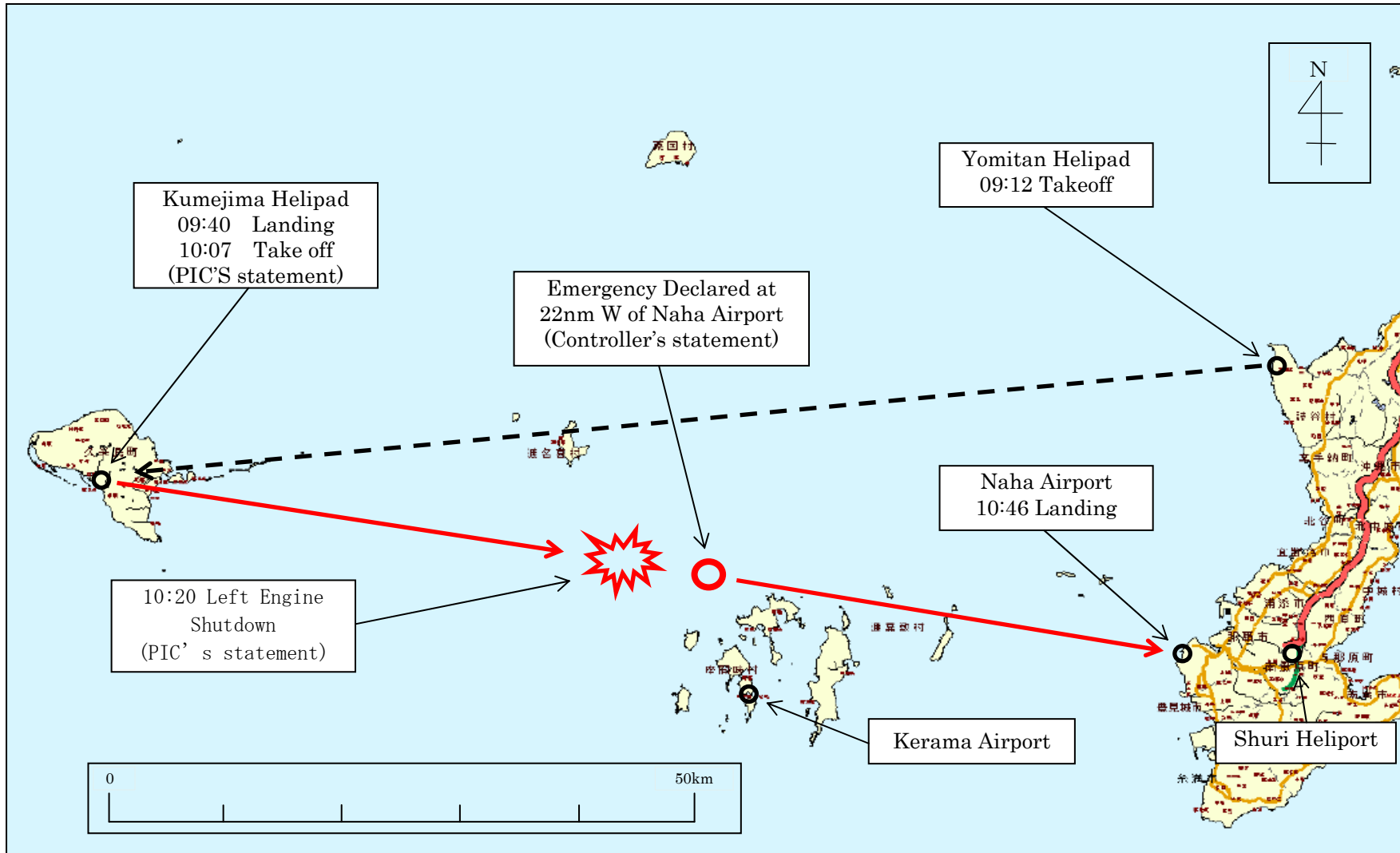

Topographical map generated by the Geospatial Information Authority of Japan

Figure 2: Three angle view of Eurocopter EC135T2

Unit : m

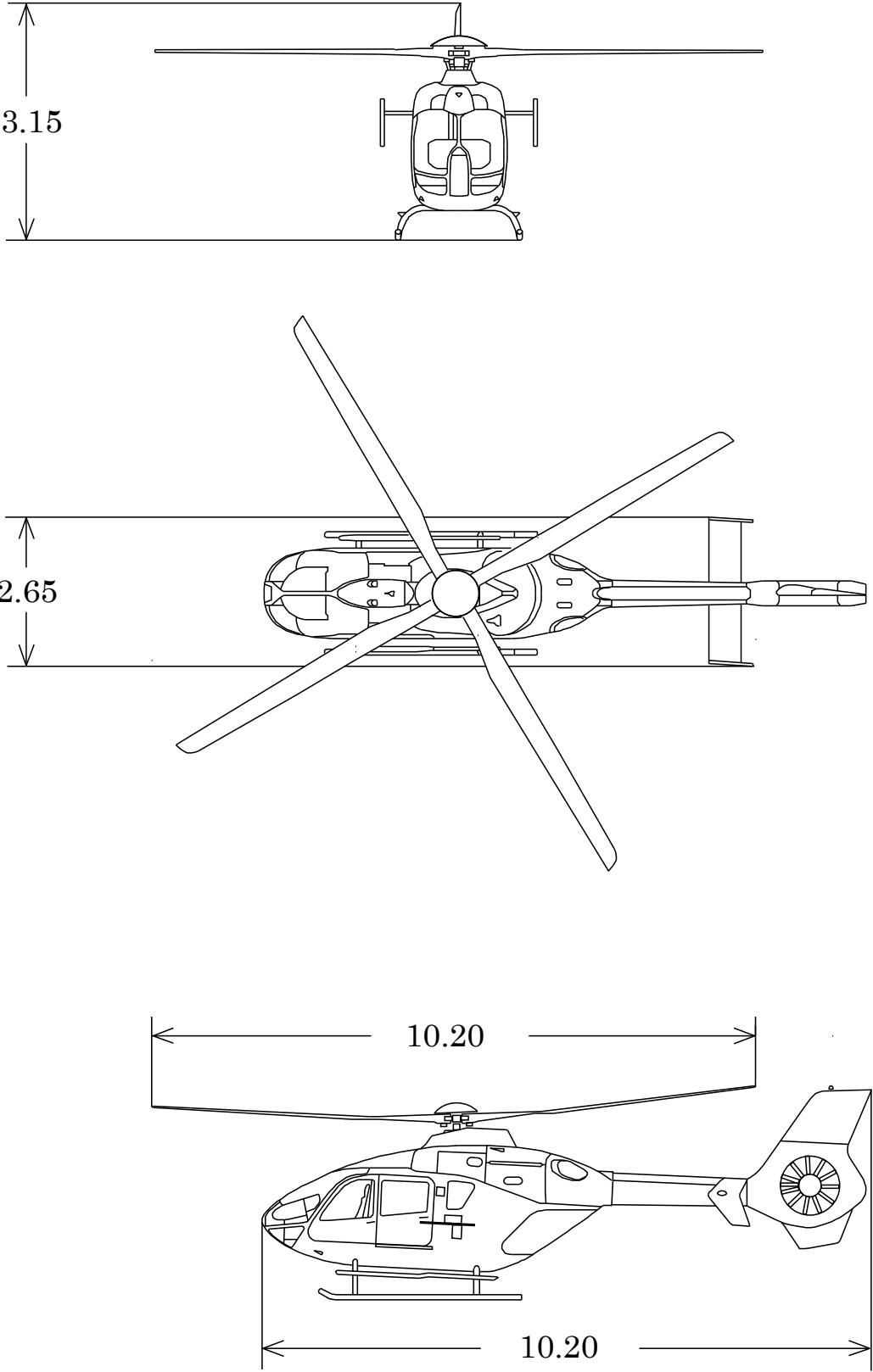
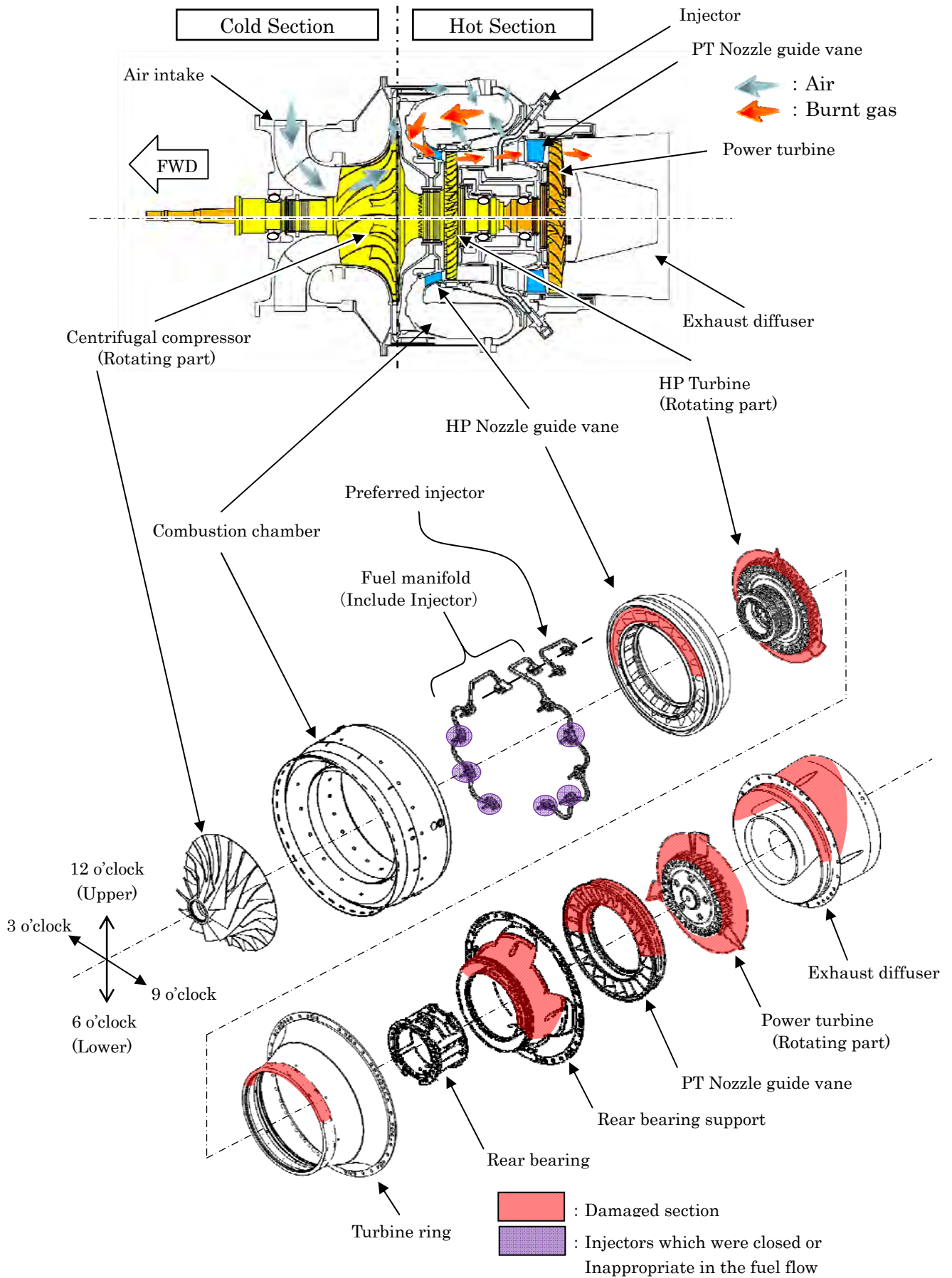
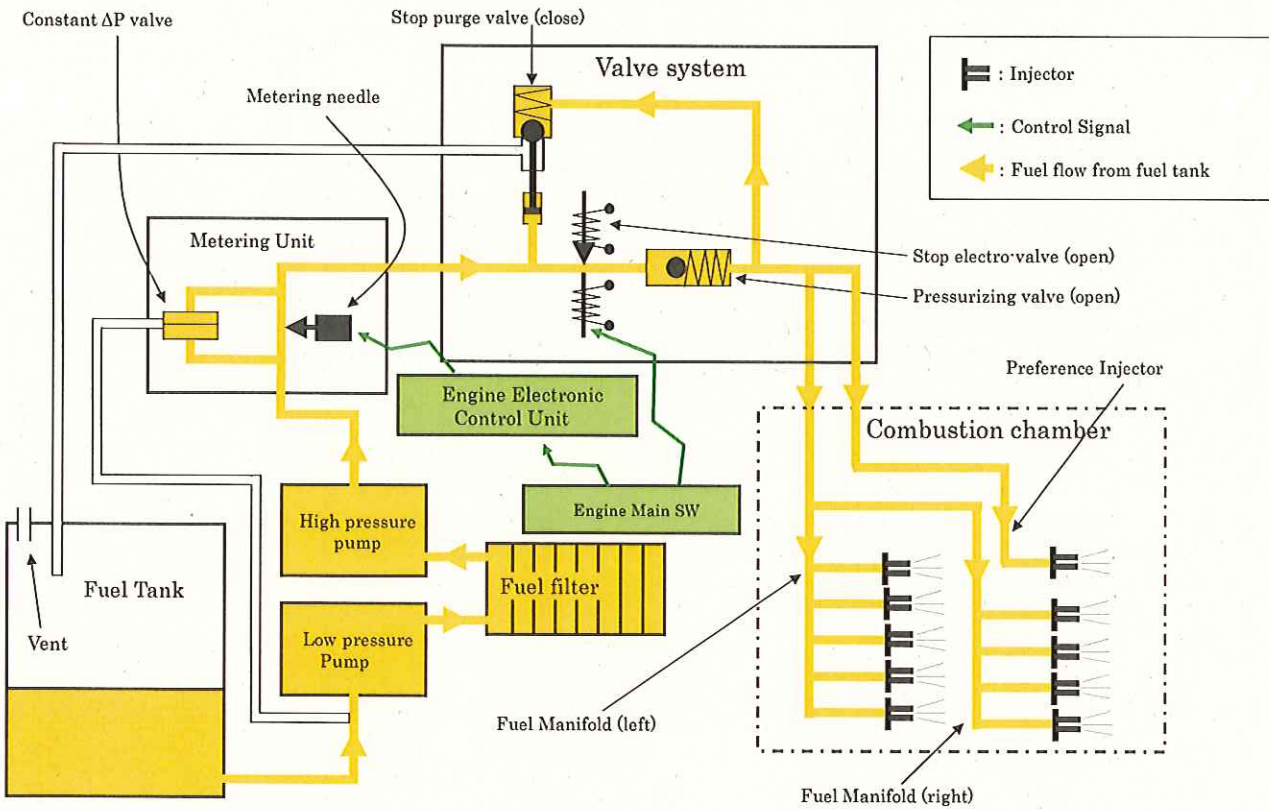

Figure 3 The Structure of the Engine and Main Sections Damaged in the Left Engine Inside



**Figure 4: Fuel Flow at the Engine Start**  
 (\*This Figure is a simplified scheme not showing all this system and function)



**Figure 5: Fuel Flow at Engine Shutdown**

(※ This Figure is a simplified schema not showing all the system and function)

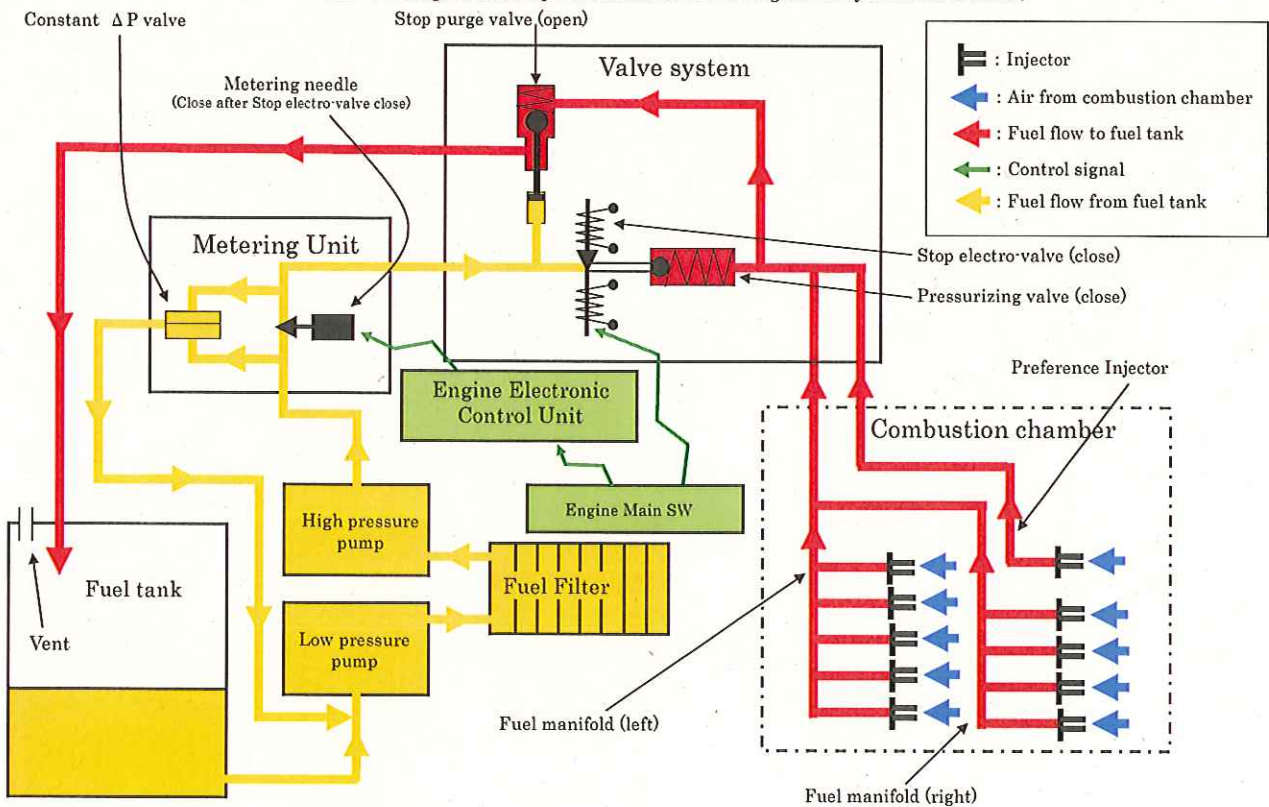

Photo 1: Serious Incident Aircraft

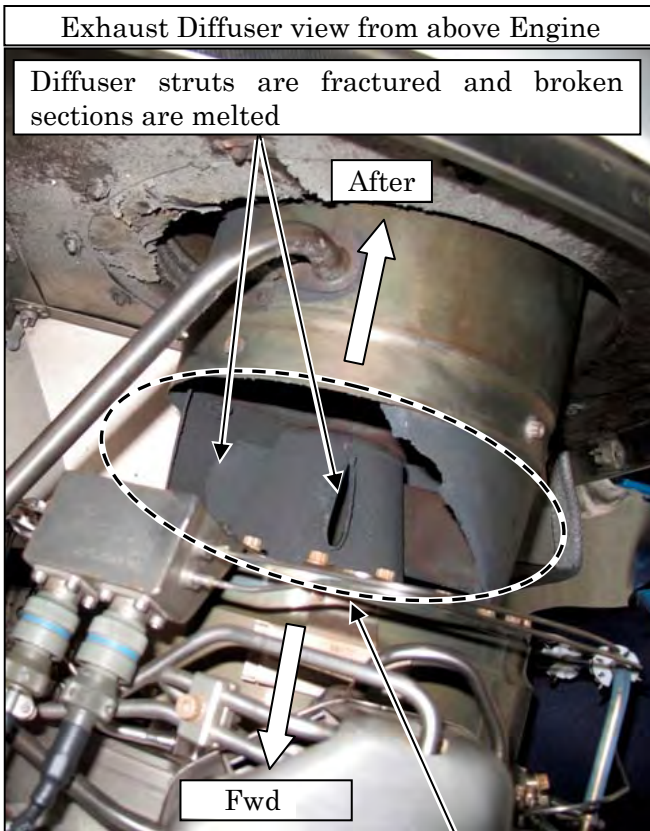

Photo 2: Display Example of ENG Instrument



※ This picture's information of engine instrument isn't a Data of Serious Incident

### Photo 3: Left Engine Interior Damage



Exhaust Diffuser was damaged

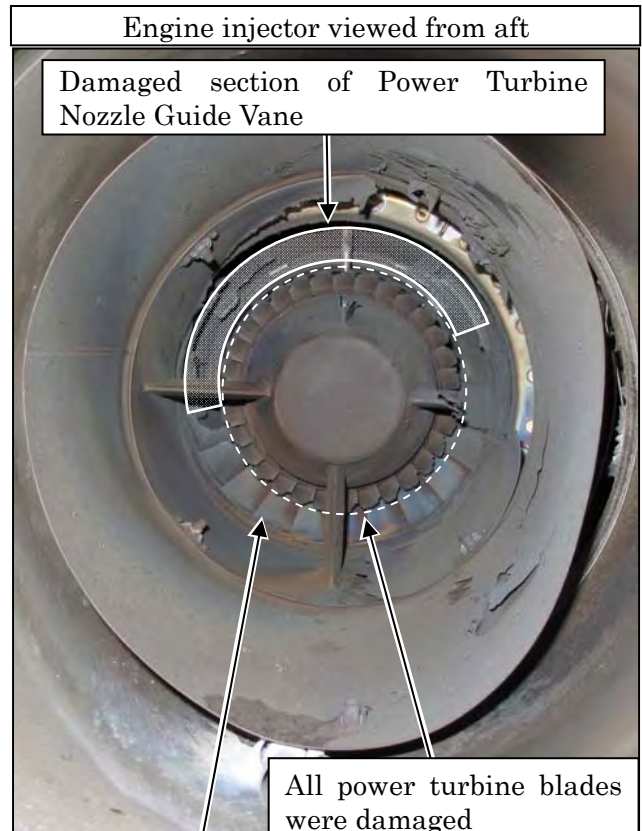

Exposed Power Turbine Nozzle Guide Vane

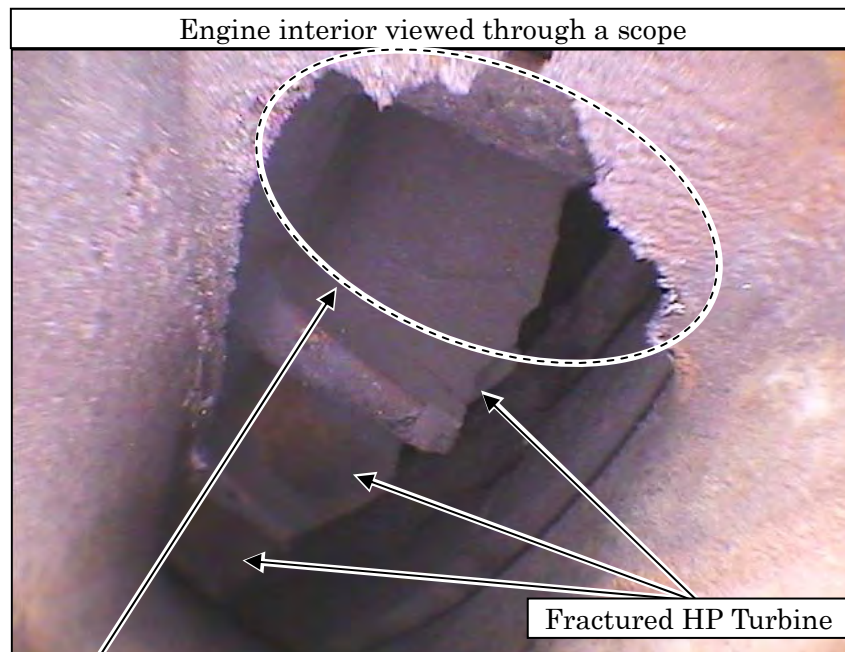

Fractured HP Nozzle Guide Vane

# Photo 4: Left Engine Interior Damage

➡ Indicates the Upper structure

Combustion

HP Nozzle Guide Vane

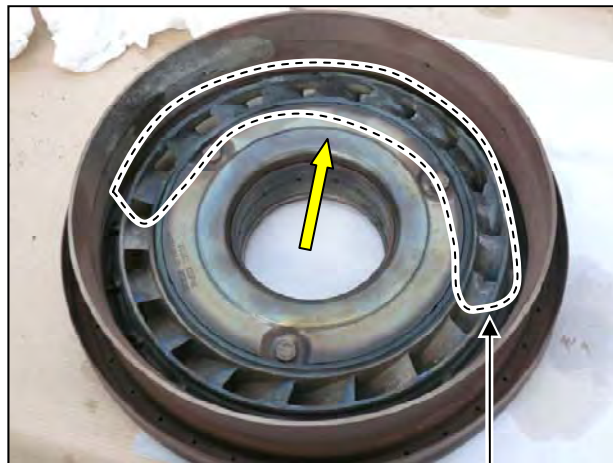
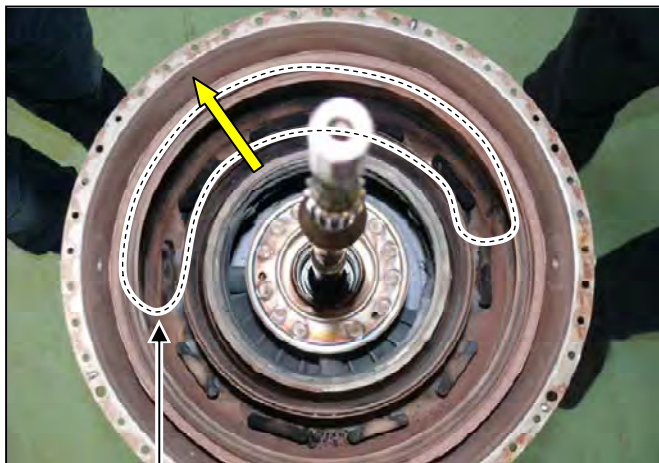

Upper interior wall is discolored black indicating being over-heated

Upper structure is discolored by over-heating and trailing edges of vanes are damaged

HP Turbine (rotating parts)

Rear Bearing  
Rear Bearing Support

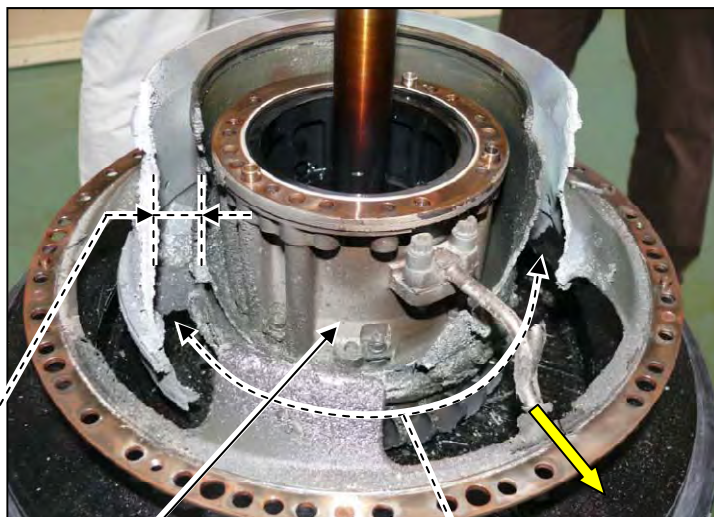
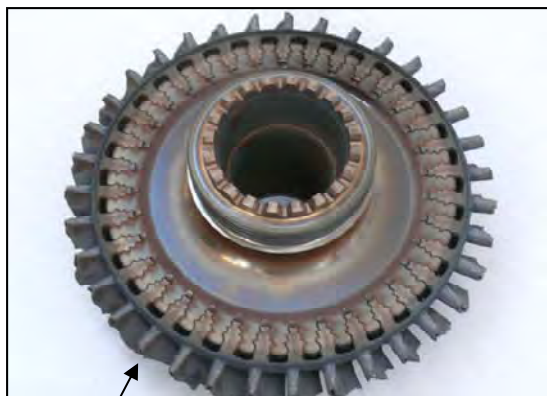

All blades are fractured at mid length

Burnt Gas rote

Segment of damaged PT Nozzle Guide vane

Fractured Rear Bearing  
(Damage rear bearing support and Exposed rear bearing)



# Photo 5 : Contaminated Fuel System Components

## 《Injector for Both Engines》

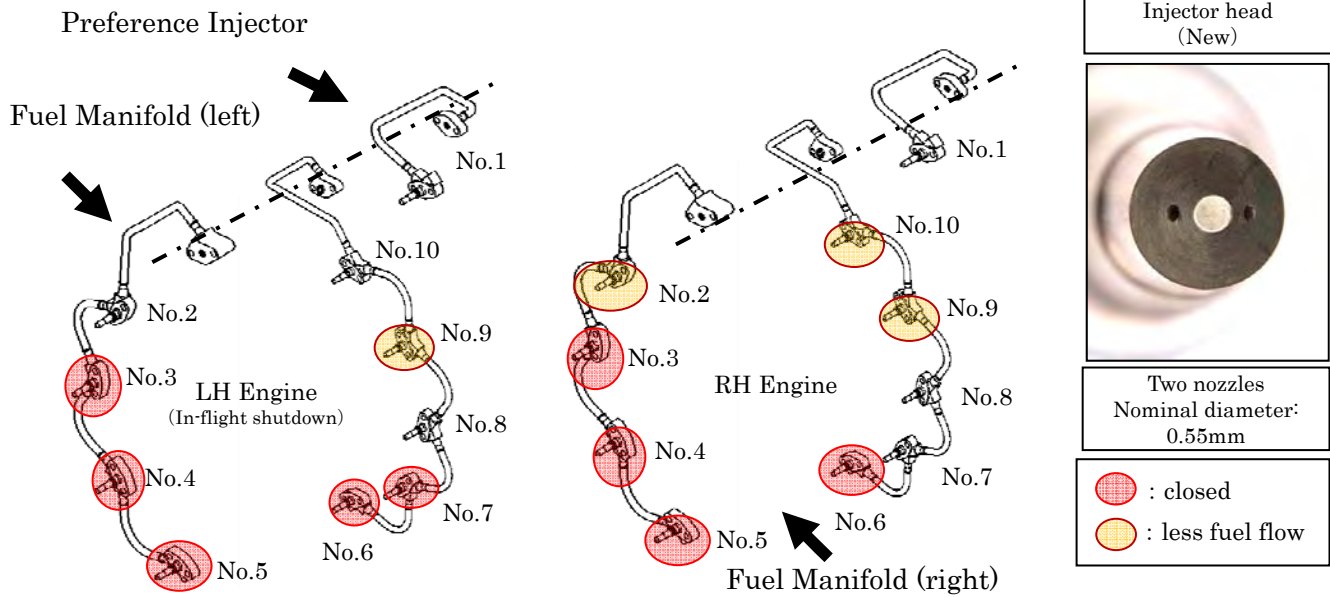

《Accumulated material on injector heads and clogged fuel nozzles for the left Engine which experienced in-flight shutdown (■ clogged)》

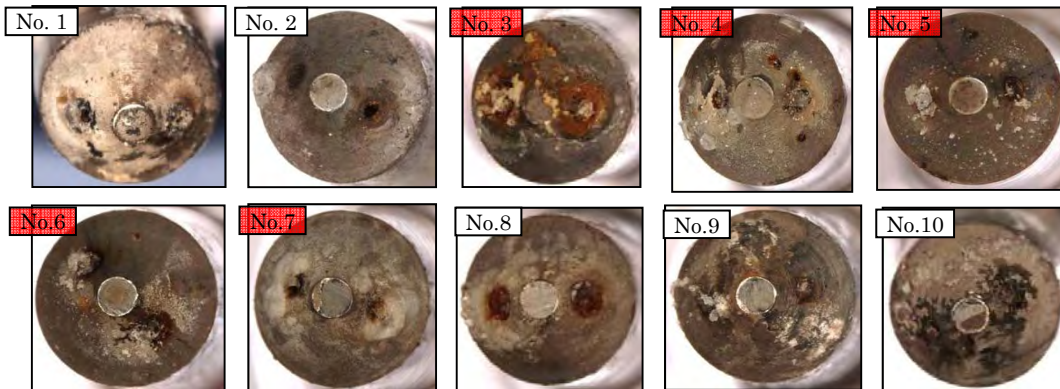

Injector heads are discolored in brown covered with accumulated with material (Analyzed to be NaCl)

### Contaminated fuel filter

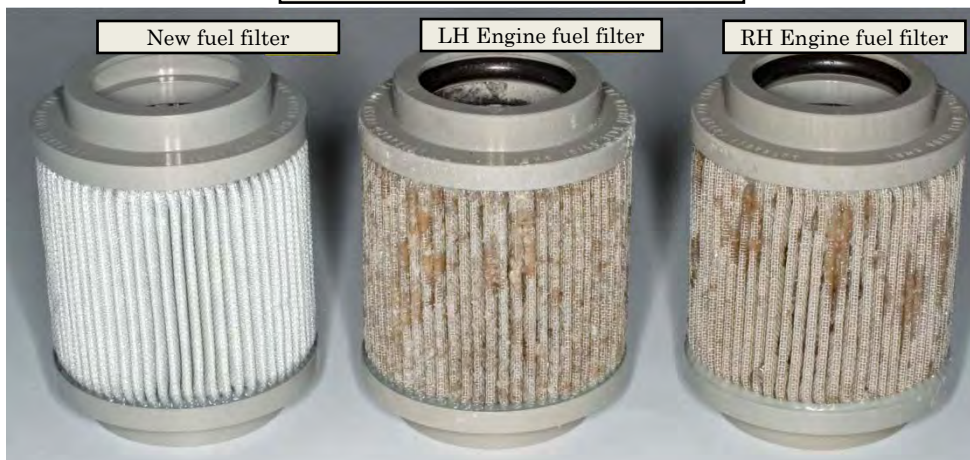

The fuel filter inlet was covered with accumulated materials. Analysis proved them to be NaCl

※ The fuel filter inlet is two layered. The outlet layer is fine metal grid. The inner layer glass fiber 20 μm grid.

Photo 6: Bird's-eye View of Yomitan Heliport

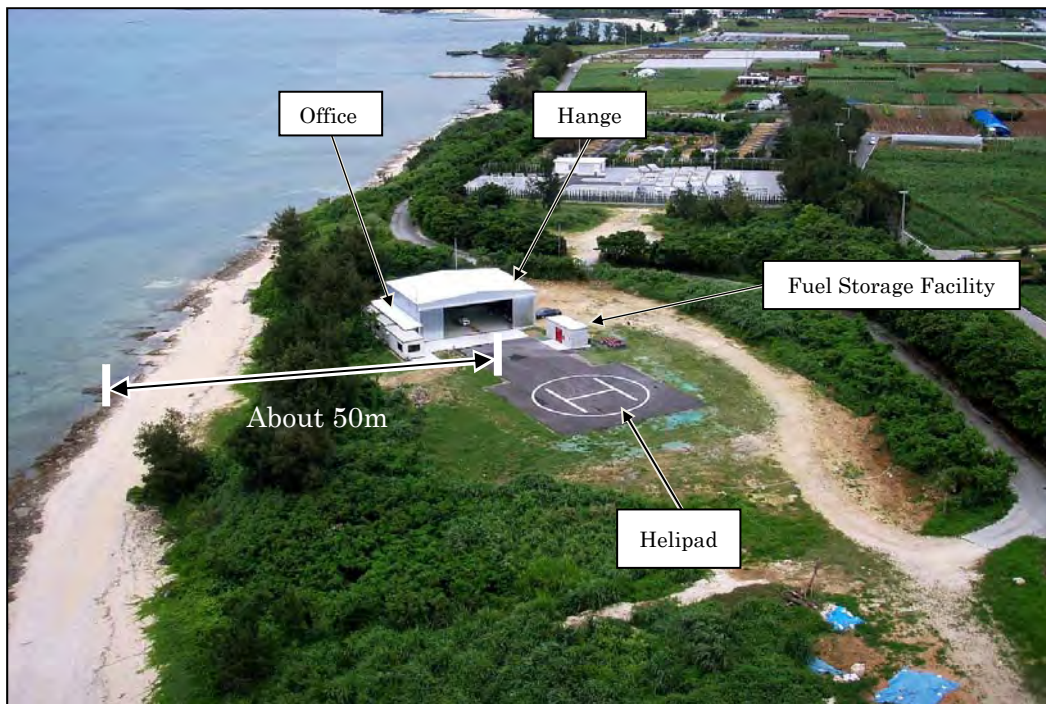
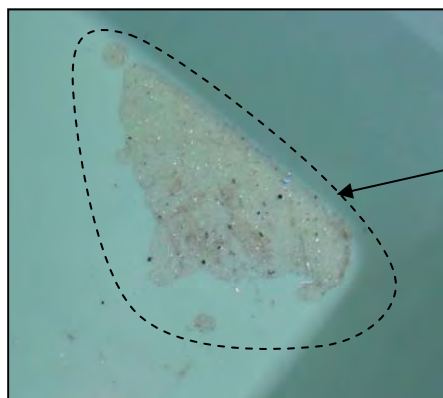
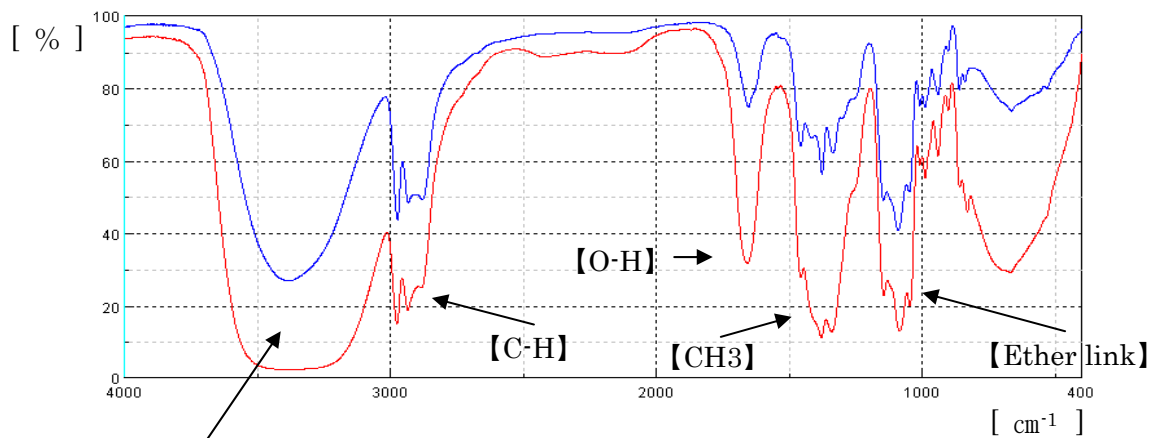

Photo 7: Transparent Liquid Taken from a Fuel Drain in Use



Transparent Liquid

《IR absorption spectrum for the fungicide》



— : Fungicide  
 — : Transparent Liquid from fuel dram

## Photo 8: Fungicide Dissolution in the Fuel

《① The fuel make an addition to fungicide and stirred》

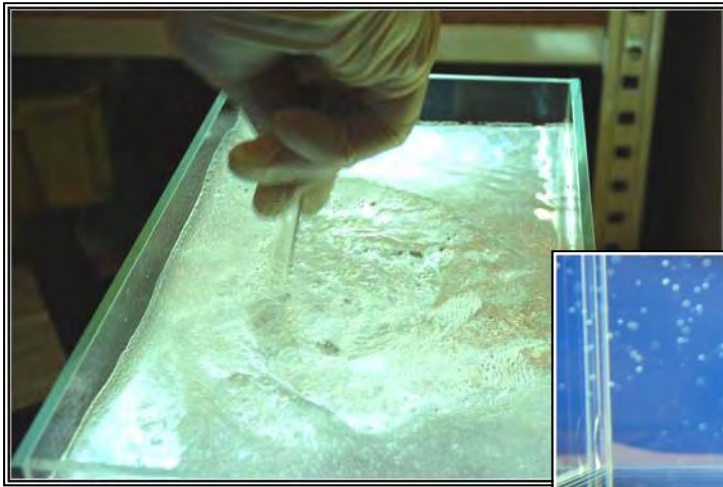

When being left stationary, the fungicide deposited

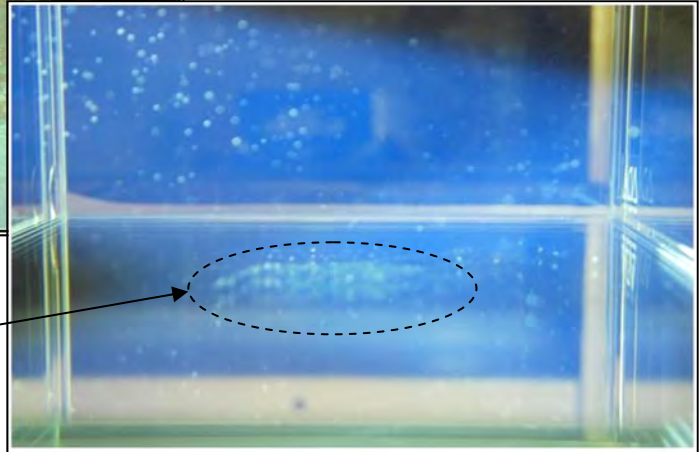

《② Seven days later》

※ The mixture was stirred once a day

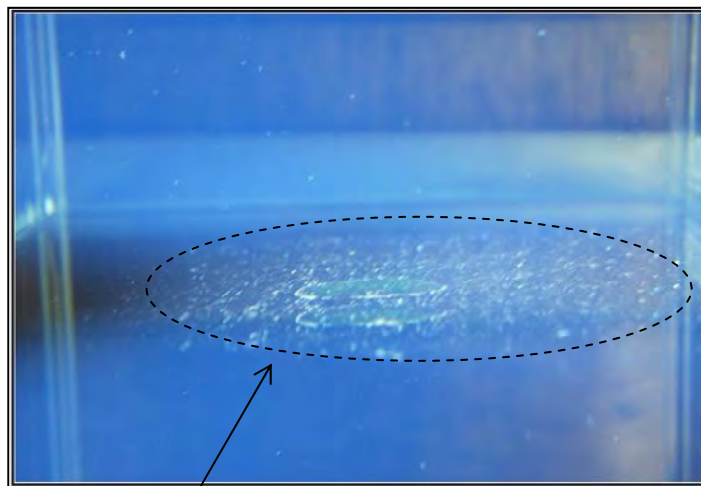

The fungicide remains deposited

# Photo 9: Permeation of the Fungicide Through the Pump Filter

«1. The fuel filter stops the fungicide»

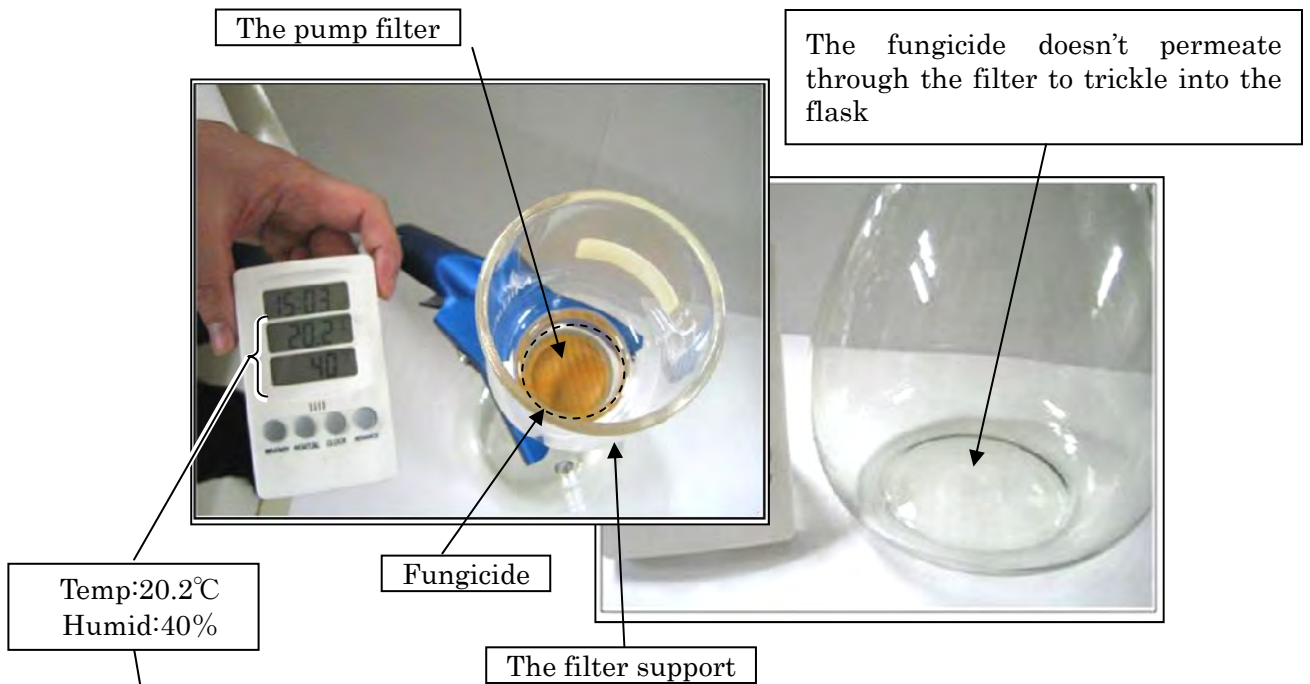

«2. The mixture of fungicide and fuel permeates through the filter»

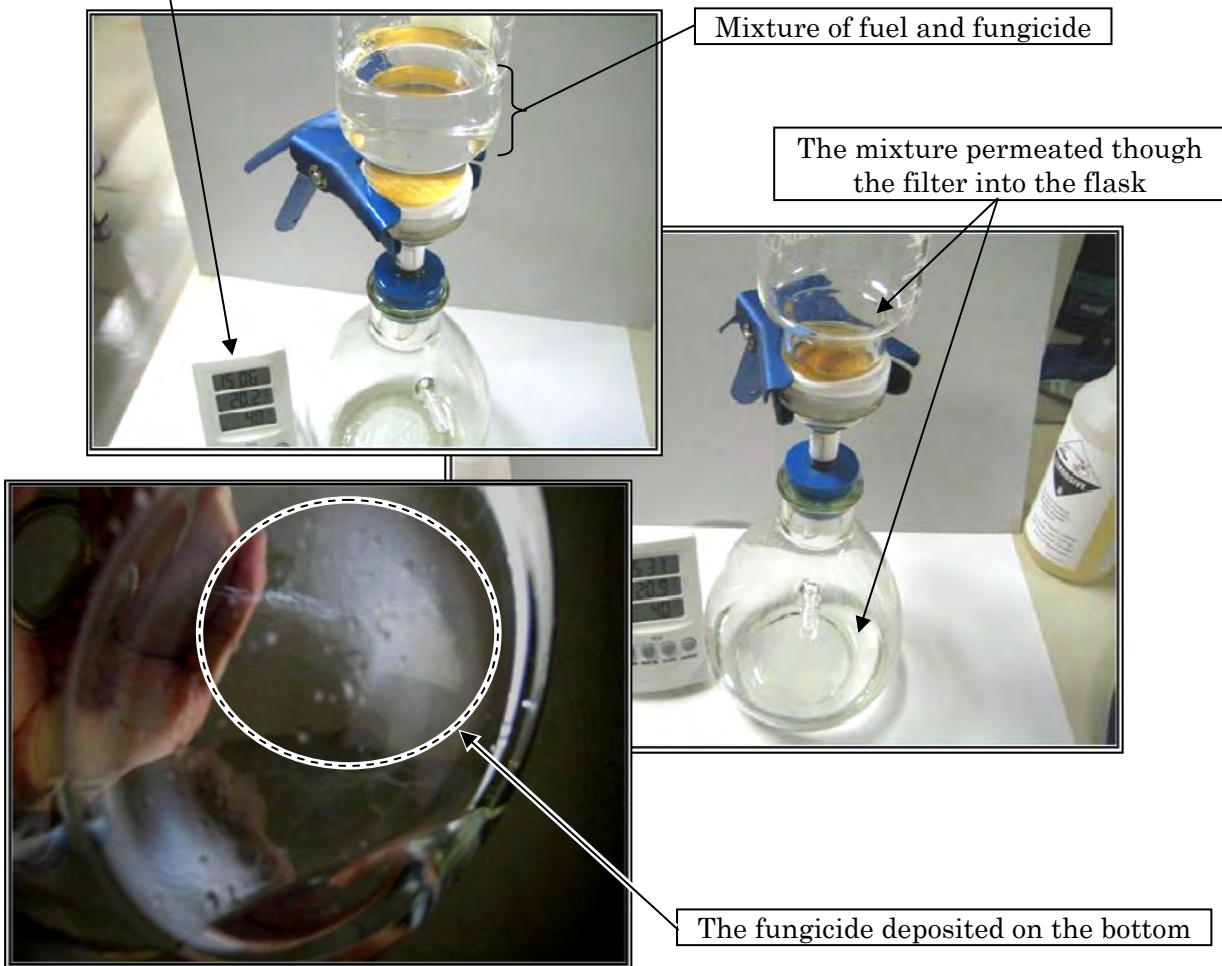

## Photo 10: Transformation of the Heated Fungicide

Being heated to 100°C

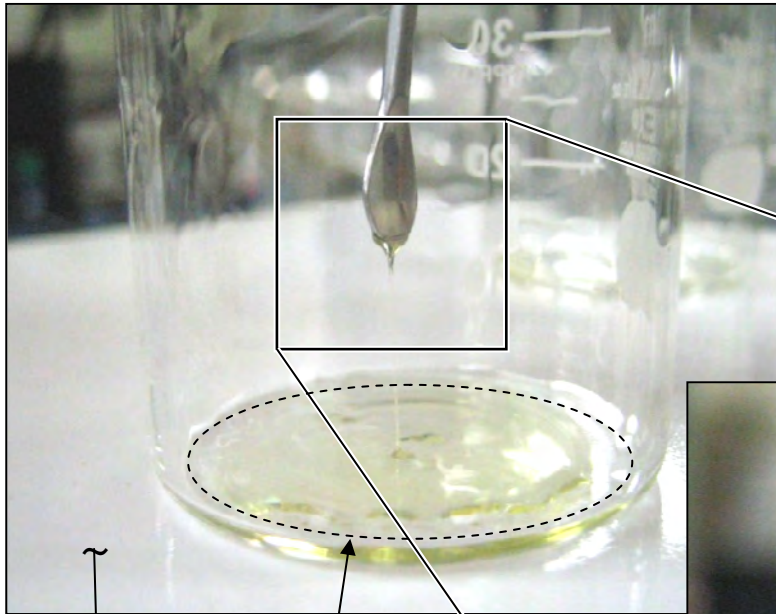

When heated, the viscosity of the fungicide is increased



At more than 200°C



At more than 200°C, the fungicide was discolored to dark brown and left on the bottom