

AI2018-5

**AIRCRAFT SERIOUS INCIDENT
INVESTIGATION REPORT**

**JETSTAR JAPAN CO., LTD.
JA04JJ**

August 30, 2018



The objective of the investigation conducted by the Japan Transport Safety Board in accordance with the Act for Establishment of the Japan Transport Safety Board and with Annex 13 to the Convention on International Civil Aviation is to prevent future accidents and incidents. It is not the purpose of the investigation to apportion blame or liability.

Kazuhiro Nakahashi
Chairman
Japan Transport Safety Board

Note:

This report is a translation of the Japanese original investigation report. The text in Japanese shall prevail in the interpretation of the report.

AIRCRAFT SERIOUS INCIDENT INVESTIGATION REPORT

UNRELIABLE AIRSPEED ON BOTH THE CAPTAIN'S SIDE AND THE
CO-PILOT'S SIDE
AT AN ALTITUDE OF 37,000 FT, 96 KM SOUTH-SOUTHEAST OF
CHUBU CENTRAIR INTERNATIONAL AIRPORT
AT 09:38 JST, JULY 9, 2016

JETSTAR JAPAN CO., LTD.
AIRBUS A320-232, JA04JJ

July 27, 2018

Adopted by the Japan Transport Safety Board

| | |
|----------|--------------------|
| Chairman | Kazuhiro Nakahashi |
| Member | Toru Miyashita |
| Member | Toshiyuki Ishikawa |
| Member | Yuichi Marui |
| Member | Keiji Tanaka |
| Member | Miwa Nakanishi |

SYNOPSIS

< Summary of the Serious Incident >

On Saturday, July 9, 2016, Airbus A320-232, registered JA04JJ, operated by Jetstar Japan Co., Ltd., was flying as a regularly scheduled 502 flight of the company, which departed from Fukuoka Airport and was heading to Narita International Airport. When the aircraft was flying at an altitude of 37,000ft and approximately 96km south-southeast of Chubu Centrair International Airport, the airspeed indication temporarily failed on the Captain's side and the Co-Pilot's side from 09:38 Japan Standard Time (JST: UTC + 9 hrs). After that, the aircraft descended to an altitude of 25,000ft and continued flight. It landed at Narita International Airport at 10:26.

There were 156 persons on board consisting of the captain, five other crewmembers, and 150 passengers. There were no injuries.

There was no damage to the aircraft.

<Probable Causes>

It is probable that this serious incident occurred because the icing occurred in the Pitot tube when the aircraft was flying at an altitude of 37,000ft, which led to the temporary failure of airspeed indication on the Captain's side and Co-Pilot's side.

It is somewhat likely that the icing of the Pitot tube occurred because the aircraft flew in an ice crystal area that was existing in the vicinity of a cumulonimbus that grew to a high altitude.

Abbreviations used in this report are as follows:

| | |
|---------|--|
| AC | : Advisory Circular |
| AD | : Airworthiness Directive |
| ADIRU | : Air Data/Inertial Reference Unit |
| ADM | : Air Data Module |
| ADR | : Air Data Reference |
| AIM-j | : Aeronautical Information Manual Japan |
| AOA | : Angle of Attack |
| AP | : Auto Pilot |
| AT | : Auto Thrust |
| ATC | : Air Traffic Control |
| BITE | : Built-in Test Equipment |
| CAOA | : Computed Angle of Attack |
| CAS | : Computed Airspeed |
| CASISIS | : Computed Airspeed Integrated Standby Instrument System |
| CFDIU | : Centralized Flight Data Interface and Management Unit |
| CVR | : Cockpit Voice Recorder |
| dB | : decibel |
| EASA | : European Aviation Safety Agency |
| ECAM | : Electronic Centralized Aircraft Monitoring |
| ELAC | : Elevator Aileron Computer |
| FCOM | : Flight Crew Operation Manual |
| FCTM | : Flight Crew Techniques Manual |
| FDR | : Flight Data Recorder |
| FL | : Flight Level |
| IR | : Insulation Resistance |
| JST | : Japan Standard Time |
| MAC | : Mean Aerodynamic Chord |
| NCD | : Non Computed Data |
| ND | : Navigation Display |
| PFD | : Primary Flight Display |
| QAR | : Quick Access Recorder |
| QRH | : Quick Reference Handbook |
| SAT | : Static Air Temperature |
| TAT | : Total Air Temperature |
| TL | : Thrust Lever |
| UTC | : Universal Time Coordinate |

Unit Conversion Table

| | |
|--------|---------------------------|
| 1 ft | : 0.3048 m |
| 1 in | : 25.40 mm |
| 1 nm | : 1,852 m |
| 1 lb | : 0.4536 kg |
| 1 kt | : 1.852 km/h (0.5144 m/s) |
| 1 atm | : 29.92 inHg : 1,013 hPa |
| 55 dBZ | : 100 mm/h |

Table of Contents

| | Page |
|---|------|
| 1. PROGRESS AND PROGRESS OF THE AIRCRAFT SERIOUS INCIDENT INVESTIGATION | 1 |
| 1.1 Summary of the Serious Incident | 1 |
| 1.2 Outline of the Serious Incident Investigation | 1 |
| 1.2.1 Investigation Organization | 1 |
| 1.2.2 Representatives of the Relevant State | 1 |
| 1.2.3 Implementation of the Investigation | 1 |
| 1.2.4 Comments from the Parties Relevant to the Cause of the Serious Incident | 1 |
| 1.2.5 Comments from the Relevant State | 1 |
| 2. FACTUAL INFORMATION | 1 |
| 2.1 History of the Flight | 2 |
| 2.1.1 History of the Flight based on Air Traffic Control Communications Records, FDR Records, and QAR Records | 2 |
| 2.1.2 Statements of Flight Crewmembers | 4 |
| 2.2 Damage to Persons | 5 |
| 2.3 Damage to the Aircraft | 5 |
| 2.4 Flight Crewmembers Information | 5 |
| 2.5 Aircraft Information | 6 |
| 2.5.1 Aircraft | 6 |
| 2.5.2 Weight and Balance | 6 |
| 2.5.3 Records of Maintenance and Repair of the Aircraft | 6 |
| 2.6 Meteorological Information | 6 |
| 2.6.1 Weather Synoptic based on Surface Weather Chart | 6 |
| 2.6.2 Radar Observatory Data | 8 |
| 2.7 Flight Recorder Information | 9 |
| 2.8 Information on Tests and Researches | 9 |
| 2.8.1 Maintenance record of the Pitot Tubes | 9 |
| 2.8.2 Tests of the Pitot Tubes | 10 |
| 2.9 Additional Information | 10 |
| 2.9.1 Icing | 10 |
| 2.9.2 Information on Ice Crystals | 10 |
| 2.9.3 Information on Unreliable airspeed indication | 15 |
| 2.9.4 NAV ADR DISAGREE Indication | 15 |
| 2.9.5 F/CTL ALTERNATE LAW Indication | 17 |
| 2.9.6 Aircraft System | 18 |
| 2.9.7 Messages Recorded on the Aircraft | 18 |
| 2.9.8 Issuance of TCD-5734B-2015 | 19 |
| 2.9.9 Revised regulations for Airspeed System | 19 |
| 2.9.10 Related Information | 19 |

| | |
|--|----|
| 3. ANALYSIS | 20 |
| 3.1 Qualifications of Crewmembers | 20 |
| 3.2 Airworthiness Certificate of the Aircraft | 20 |
| 3.3 Relations to the Meteorological Conditions | 20 |
| 3.4 Events Related to the Aircraft | 20 |
| 3.4.1 Damage to No. 2 Pitot Tubes | 20 |
| 3.4.2 Unreliable airspeed indication | 21 |
| 3.5 Avoiding Ice Crystals | 22 |
| | |
| 4. PROBABLE CAUSES | 23 |
| | |
| 5. SAFETY ACTIONS | 23 |
| 5.1 Prevention Measures of Recurrence Taken After the Incident | 23 |
| 5.1.1 Safety Actions Taken by the Company | 23 |
| | |
| ATTACHMENT | |
| Appended Figure 1: A320-232 Airbus Three-View drawings | 24 |
| Photo 2: Serious incident aircraft | 24 |
| Appended Figure 2: Record of FDR and others | 25 |

1. PROGRESS AND PROGRESS OF THE AIRCRAFT SERIOUS INCIDENT INVESTIGATION

1.1 Summary of the Serious Incident

On July 9 (Saturday), 2016, Airbus A320-232, registered JA04JJ, operated by Jetstar Japan Co., Ltd., was flying as a regularly scheduled 502 flight of the company, which departed from Fukuoka Airport and was heading to Narita International Airport. When the aircraft was flying at an altitude of 37,000ft and approximately 96km south-southeast of Chubu Centrair International Airport, airspeed indication temporarily failed on the Captain's side and the Co-Pilot's side from 09:38 Japan Standard Time (JST: UTC + 9 hrs, unless otherwise stated all times are indicated in JST on a 24-hour clock). After that, the aircraft descended to an altitude of 25,000ft and continued flight. It landed at Narita International Airport at 10:26.

There were 156 persons on board consisting of the captain, five other crewmembers, and 150 passengers. There were no injuries.

There was no damage to the aircraft.

1.2 Outline of the Serious Incident Investigation

The occurrence covered by this report falls under the category of “Multiple malfunctions in one or more systems equipped on aircraft impeding the safe flight of aircraft” as stipulated in Clause 9, Article 166-4 of the Ordinance for Enforcement of Civil Aeronautics Act of Japan (Ordinance of the Ministry of Transport No. 56 of July 31, 1952), and is classified as a serious incident.

1.2.1 Investigation Organization

On July 12, 2016, the Japan Transport Safety Board (JTSB), upon receipt of the notification of the occurrence of a serious incident, designated an investigator-in-charge and two other investigators to investigate this serious incident.

1.2.2 Representatives of the Relevant State

An accredited representative and an adviser of the French Republic, as the State of Design and Manufacture of the aircraft involved in the serious incident, and an accredited representative of the United States of America, as the State of Manufacture of parts of the aircraft, participated in the investigation.

1.2.3 Implementation of the Investigation

July 12-13, 2016: Interviews and aircraft examination

August 24-25, 2016: Detailed investigation of the Pitot tubes

1.2.4 Comments from the Parties Relevant to the Cause of the Serious Incident

Comments were invited from parties relevant to the cause of the serious incident.

1.2.5 Comments from the Relevant State

Comments on the draft report were invited from the Relevant State.

2. FACTUAL INFORMATION

2.1 History of the Flight

On July 9, 2016, Airbus A320-232, registered JA04JJ (hereinafter referred to as "the Aircraft"), operated by Jetstar Japan Co., Ltd. (hereinafter referred to as "the Company"), took off, as a regularly scheduled Flight 501 of the Company, from Narita International Airport and landed at Fukuoka Airport. The Aircraft took off from Fukuoka Airport as a regularly scheduled Flight 502 of the Company at 08:50, and was flying back to Narita International Airport.

There were 156 persons on board consisting of the captain (hereinafter referred to as "the Captain"), five other crewmembers, and 150 passengers.

When the serious incident occurred, the Captain sat in the left seat in the cockpit of the Aircraft as the PF*1 and the Co-Pilot sat in the right seat as the PM*1.

The flight plan of the Aircraft is outlined below:

Flight rules: Instrument flight rules (IFR); Departure aerodrome: Fukuoka Airport; Estimated off-block time: 08:40; Cruising speed: 452 kt; Cruising altitude: FL*2 370; Route: SABAR - Y81 (RNAV route) - BINKS; Destination aerodrome: Narita International Airport; Total estimated elapsed time: One hour 24 minutes; Fuel load expressed in endurance: Two hours 40 minutes; Alternative aerodrome: Tokyo International Airport

The history of the flight up to the time of the serious incident is summarized below, based on the statements of the Captain and Co-Pilot, the records of the flight data recorder (hereinafter referred to as "the FDR"), and the air traffic control communications records.

2.1.1 History of the Flight based on Air Traffic Control Communications Records, FDR*3 Records and QAR*4 Records

Around 09:14 When the Aircraft was flying at FL370, it requested Fukuoka Control for a course deviation 20 nm north from the scheduled route to avoid adverse weather conditions, and received an approval.

Around 09:20 The Aircraft requested that it deviate another 5 nm northward to avoid adverse weather conditions, and received an approval.

09:23:16 The Aircraft told Tokyo Control that the deviation of 25 nm northward for avoiding adverse weather conditions had been approved. Tokyo Control instructed the Aircraft to report when the Aircraft could make a direct flight to BUNGU (waypoint).

09:30:18 The Aircraft requested a direct flight to BUNGU, which was approved.

09:33:11 The Aircraft requested a deviation of 25 nm southward for avoiding adverse weather conditions, which was approved.

09:36:18 The Aircraft reported its location as FL370 above ISEBI (waypoint).

09:37:07 Tokyo Control asked if the Aircraft could fly direct to BUNGU. However, the

*1 "PF (Pilot-Flying)" and "PM (Pilot-Monitoring)" are terms used to identify pilots based on their roles on an aircraft flown by two pilots. The PF is mainly in charge of flying. The PM is mainly in charge of monitoring of the flight conditions of the aircraft, cross-checking of the operation by the PF, and duties other than flying.

*2 "FL" stands for Flight Level. It is the pressure altitude in the standard atmosphere. The FL is expressed in the value dividing the reading on the altimeter by 100, when the altimeter is set to 29.92 inHg. In Japan, flight level is usually used at flight altitudes of 14,000 ft or higher. For example, FL200 represents the altitude of 20,000 ft.

*3 See 2.7 for the description of "FDR".

*4 "QAR" stands for Quick Access Recorder. It usually refers to equipment that records flight data for the purpose of improving the quality of flight operation.

Aircraft requested that it avoid adverse weather conditions due to a medium degree of shaking. Tokyo Control approved it and requested a report when the Aircraft had flown through the adverse weather area.

09:37:42 The pointer of the AOAIRS*⁵ 2 started to fluctuate wildly.

09:37:53 The pointer of the CAS*⁶ started to fluctuate wildly two seconds after the pointer of the AOAIRS 2 stopped vibrating. The ECAM*⁷ displayed the message “NAV ADR DISAGREE*⁸.”

09:37:55 Auto Pilot (AP) and Auto Thrust (AT) were automatically turned off. After three seconds, the Captain voluntarily disconnected AP.

09:38:03 The Aircraft requested descent, and Tokyo Control instructed the Aircraft to descend to FL350. The Aircraft further requested descent to FL250 due to “Unreliable airspeed,” which was approved. AP and AT were turned off. It was indicated that the altitude of the Aircraft temporarily increased. At this time, the difference in altitude readings between the altimeter and integrated secondary flight display system recorded on the FDR reached 800 ft.

09:39:36 The Aircraft requested direct flight to BUNGU, which was approved. The thrust leveler was set to the CLIMB position.

09:45:50 The Aircraft reported to Tokyo Control that it might have encountered heavy icing at around FL370 and that airspeed indication could not be read temporarily, which then recovered.

*5 “AOAIRS” is the AOA (angle of attack) data directly detected by the AOA probe, corrected by adding data from the inertia reference unit that acquires location information. When the CAS reading is 60 kt or less, AOAIRS becomes NCD (non-computed data). See footnote 6 for the description of CAS.

*6 “CAS” stands for Computed Airspeed. It indicates speed data in kt from ADR 1 or ADR 2. See footnote 25 for the description of ADR.

*7 “ECAM” stands for Electronic Centralized Aircraft Monitoring. Located in the middle of the instrument panel in the cockpit, this equipment provides flight crewmembers with visual information on aircraft system conditions, failures, check lists or operating conditions.

*8 See 2.9.4 for the description of “NAV ADR DISAGREE.”

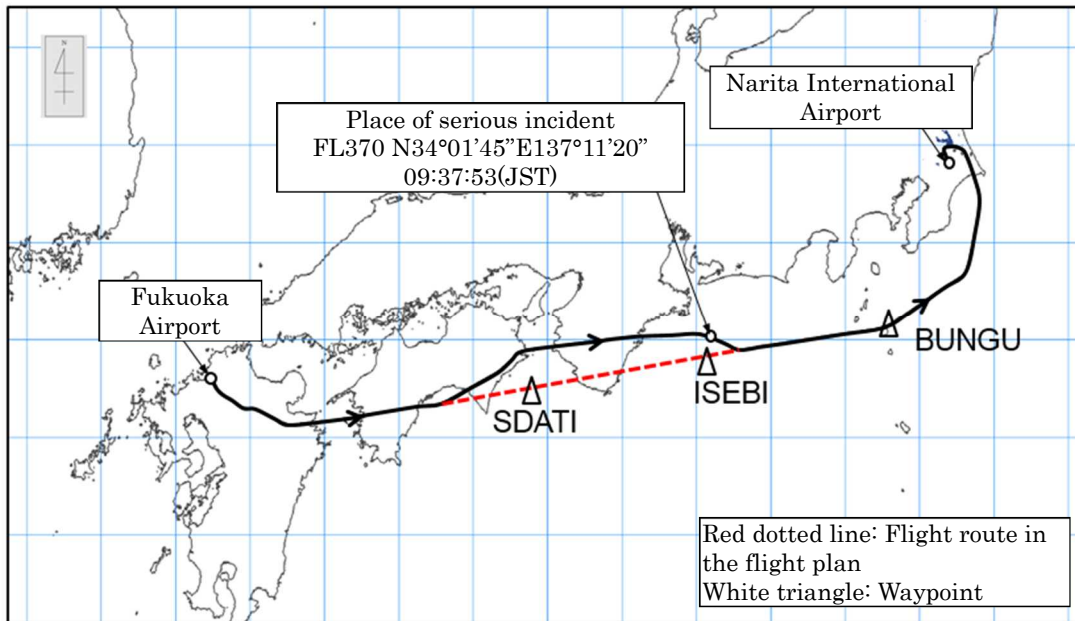

Figure 1: Estimated flight route

2.1.2 Statements of Flight Crewmembers

(1) The Captain

Since the weather at Narita Airport was becoming worse, extra fuel^{*9} was added to the Aircraft in addition to the fuel quantity in the flight plan. The Captain told the passengers that shaking might start in about 40 minutes after departure from Fukuoka Airport.

When the Aircraft was cruising at FL370, green and intermittent yellow belt-shaped echoes appeared on the on-board radar. Therefore, the Aircraft was flown approximately 20nm north of the route specified in the flight plan when it reached 80nm before (west of) SDATI (waypoint). When the Aircraft was abeam ISEBI, the sound of rain hitting the airframe was heard. The SAT (static air temperature) at that time was -44°C. Immediately after that, the Co-Pilot said that the airspeed indication on the PFD on the Co-Pilot's side was not normal. The airspeed indication pointer on the Co-Pilot's side fluctuated up and down widely. When the airspeed indication on the PFD on the Captain's side was checked, the airspeed indication pointer also fluctuated up and down widely. When the airspeed indication on the Co-Pilot's side was checked again, a flag appeared, indicating a airspeed indication failure. The Captain turned off AP and AT, and flew the Aircraft while keeping the pitch attitude angle between 2.5° and 5.0° so as to prevent the Aircraft from stalling. The stall warning was not appeared.

The ECAM displayed the message “NAV ADR DISAGREE.” The PFD indicated that the flight control computer had transitioned to the Alternate Law^{*10}.

The Aircraft asked the ATC^{*11} for descent. Because the airspeed indication on the

^{*9} “Extra fuel” refers to the fuel to be added based on the decision of the Captain and/or flight dispatcher. It is sometimes added when a change in weather conditions at the destination or alternative aerodrome is expected.

^{*10} See 2.9.5 for the description of “Alternate Law.”

^{*11} “ATC” stands for Air Traffic Control. Although it is a general term, it refers to the Kanto South B sector of the

Captain's and Co-Pilot's sides returned to normal soon after the Aircraft started descent, the Captain turned on AT and AP were started again manually. The Captain visually checked the main wing and ice indicator, but there was no icing.

When the Aircraft descended to FL250, the Captain explained the incident to the cabin attendants, and continued flight to the destination.

(2) The Co-Pilot

The Co-Pilot thought that the Aircraft was flying through clouds. The echos on the on-board radar were green. Although slight shaking continued, the Co-Pilot did not feel anything unusual. The Co-Pilot noticed unstable airspeed indication when a sound as if rain were hitting the front window of the cabin was heard when the Aircraft was near abeam ISEBI. Feeling strange about the rain sound at such a high altitude, the presence of Ice crystals^{*12} crossed the Co-Pilot's mind.

Soon after the Aircraft started decent, the Captain said that the airspeed indication had returned to normal. When the airspeed indication on the Co-Pilot's side and that on the integrated secondary flight display system were checked, the readings seemed to be normal.

The ALL mode^{*13} was selected for the on-board radar during flight.

2.2 Damage to Person

There were no injuries.

2.3 Damage to the Aircraft

There was no damage to the Aircraft.

2.4 Flight Crewmembers Information

(1) Captain Male, Age 43

| | |
|--|---------------------|
| Airline transport pilot certificate (Airplane) | December 20, 2013 |
| Type rating for Airbus A320 | May 7, 2012 |
| Class 1 aviation medical certificate | |
| Validity | February 9, 2017 |
| Total flight time | 7,184 hr and 25 min |
| Flight time in the last 30 days | 64 hr and 46 min |
| Flight time on the type of aircraft | 2,997 hr and 56 min |
| Flight time in the last 30 days | 64 hr and 46 min |

(2) Co-pilot Male, Age 35

| | |
|---|-----------------|
| Commercial pilot certificate (Airplane) | August 13, 2009 |
|---|-----------------|

Tokyo Area Control Center.

*12 See 2.9.2 for the description of "Ice crystals."

*13 See 2.9.6.4 for the description of "ALL mode."

| | |
|--------------------------------------|---------------------|
| Type rating for Airbus A320 | January 9, 2015 |
| Instrument flight certificate | March 12, 2010 |
| Class 1 aviation medical certificate | |
| Validity | October 13, 2016 |
| Total flight time | 3,151 hr and 38 min |
| Flight time in the last 30 days | 81 hr and 42 min |
| Flight time on the type of aircraft | 1,355 hr and 27 min |
| Flight time in the last 30 days | 81 hr and 42 min |

2.5 Aircraft Information

2.5.1 Aircraft

| | |
|--|----------------------|
| Type | Airbus A320-232 |
| Serial number | 5245 |
| Date of manufacture | August 6, 2012 |
| Certificate of airworthiness | |
| Validity : From July 17, 2016 to July 30, 2017 | |
| Category of airworthiness | Airplane Transport T |
| Total flight time | 9,938 hr and 39 min |
| Flight time since the last periodic inspection (2C Heavy Maintenance on October 26, 2015) | 1,897 hr and 31 min |
| (See Appended Figure 1 “Three-View Drawing of Airbus A320-232”) | |

2.5.2 Weight and Balance

When the serious incident occurred, the Aircraft’s weight is estimated to have been 134,600 lbs and the position of the center of gravity is estimated to have been 33.6% MAC*¹⁴, both of which are highly probable to have been within the allowable range (maximum take-off weight of 169,750 lbs, and 20.5 to 38.2% MAC corresponding to the weight at the time of the serious incident).

2.5.3 Records of Maintenance and Repair of the Aircraft

According to the maintenance records of the Aircraft, the airspeed system and static pressure system were inspected, and no problem was found in the heavy maintenance conducted from September to October 2015.

2.6 Meteorological Information

2.6.1 Weather Synoptic Based on Surface Analysis Chart

- (1) According to the surface analysis chart released by the Japan Meteorological Agency

*14 “MAC” stands for Mean Aerodynamic Chord, meaning a chord that represents the aerodynamic characteristics of a wing. It is the representative chord length if the chord is not constant as in the case of a sweptback wing. 33.6% MAC indicates a position located at a distance of 33.6% from the leading edge of the mean aerodynamic chord.

(JMA) on July 9, 2016 at 09:00, a front was extended from the Kanto coastal sea to the southern part of Kyushu, and there was a low pressure with central pressure of 1,006 hPa on the front, which was moving to the east. In addition, there was the first typhoon with a central pressure of 985 hPa near Taiwan. (See Figure 2.)

According to the short-range forecast reference released by the JMA at 03:40 on the same day, the low pressure was expected to pass eastern Japan via western Japan on the night of the 9th, and reach the area above the sea east of the Kanto region in the early hours of the 10th. Due to the influence of warm humid air attracted by the low pressure, the state of the atmosphere was expected to become very unstable from western Japan to eastern Japan from the 9th, causing very heavy rain mainly on the Pacific side. In western Japan where the front would be stationary, a large amount of precipitation was expected.

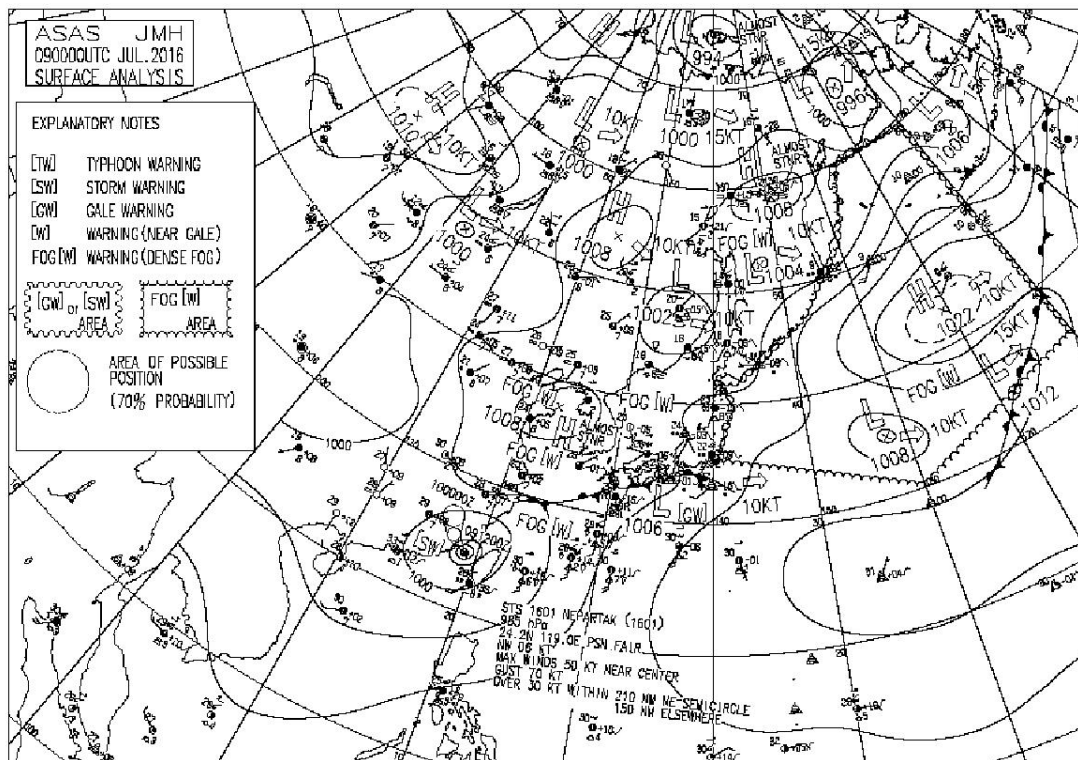

Figure 2: Surface analysis chart released on July 9, 2016 at 09:00

- (2) According to the domestic significant weather forecast chart for the next six hours released by the JMA on July 9, 2016 at 03:15, significant weather areas (inside the cloud shapes) were expected to expand to part of the Tokai region, and to the southern part of the Kinki region and the eastern part of the Shikoku region, moving to the east at a speed of 15 kt. Along with this, a medium air turbulence and icing, rain, thunderbolts, and cumulus clouds, including cumulonimbus clouds, with a cloudiness of around 5/8 to 7/8 (BKN^{*15}) were expected. (See Figure 3.)

The Captain obtained this significant weather forecast chart from the flight dispatcher

*15 "BKN" refers to the cloudiness of 5/8 to 7/8 in reporting the apparent ratio of the area covered by clouds to the entire sky.

in the briefing at the time of the departure from Narita International Airport for the first flight on the day of the serious incident.

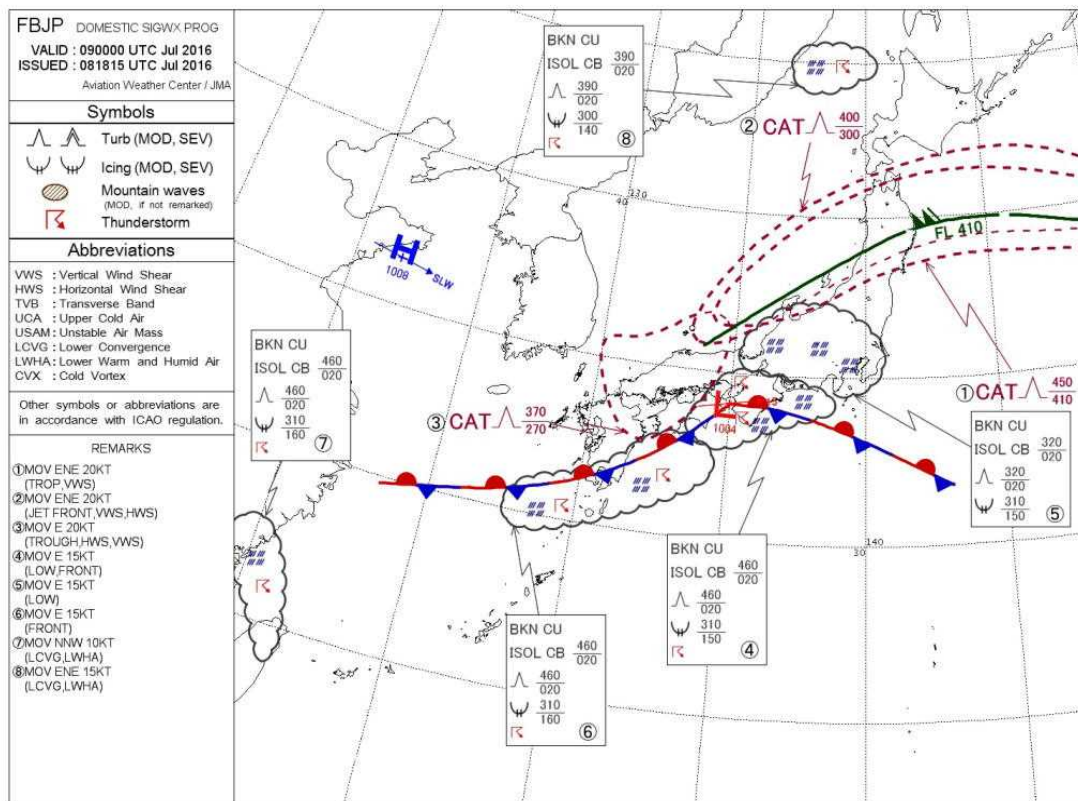

Figure 3: Domestic significant weather forecast chart released on July 9, 2016 at 03:15

2.6.2 Radar Observatory Data

(1) Echo intensity

According to the echo intensity^{*16} chart provided by the JMA (hereinafter referred to as “the echo intensity chart”), there was a narrow echo area with a very strong intensity that corresponds to a rainfall of 80 mm/h or more at directly south of the area near the place of the serious incident at 9:40 (JST). In addition, there were wide echo areas that correspond to a rainfall of 16 to 24 mm/h and 24 to 32 mm/h on the south side of the ocean off the Tokaido region. (See Figure 4 Composite chart of echo intensity chart and estimated flight path.)

(2) Echo peak altitude

According to the echo peak altitude^{*17} chart provided by the JMA (hereinafter referred

*16 “Echo intensity” refers to the displayed intensity of a precipitation area which is obtained by converting to the amount of precipitation the radio echo reflected from clouds that contain moisture to the JMA's weather radar on the ground.

*17 “Echo peak altitude” refers to the maximum altitude of a radar echo that is displayed based on radar

to as “the echo peak altitude chart”), there was an echo with a peak altitude of 12 to 14 km (39,370 to 45,931 ft) at directly south of the area near the place of the serious incident at 9:40 (JST). (See Figure 5 Composite chart of echo peak altitude chart and estimated flight path.)

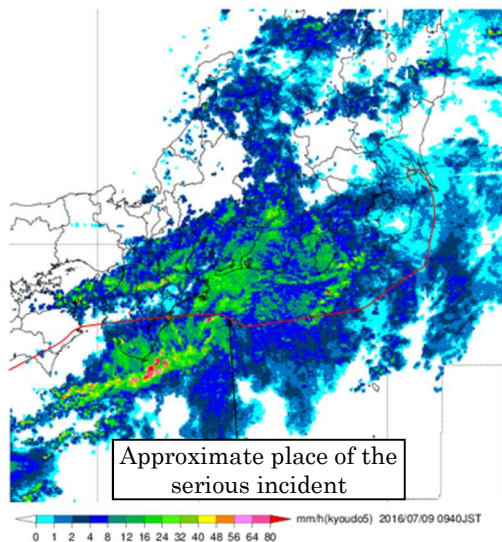

Figure 4: Composite chart of echo intensity chart and estimated flight path

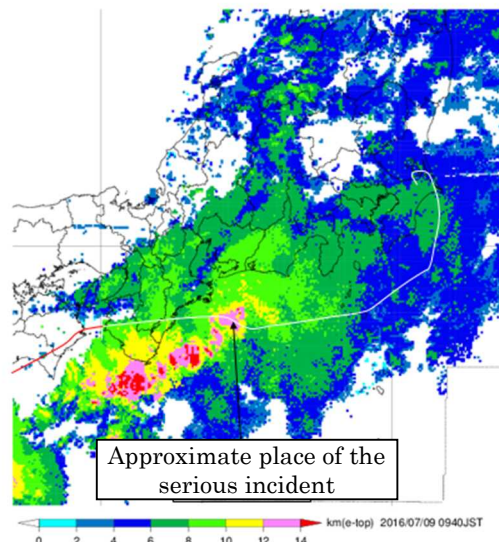

Figure 5: Composite chart of echo peak altitude chart and estimated flight path

2.7 Flight Recorder Information

The Aircraft was equipped with U.S. Honeywell's FDR which can retain approximately 25 hours of data and U.S. L3 Communications' CVR*18 which can retain approximately 2 hours of data. The Aircraft continued flight without unloading the FDR and CVR after the serious incident occurred. Although the FDR retained the records when the serious incident occurred, the records on the CVR were overwritten and erased. To complement the records on the FDR, data recorded on the QAR was also utilized.

The time data in FDR was calibrated by correcting the time signals in the ATC communication records with the VHF transmission keying signals in FDR.

With regard to CAS, it is not recorded whether ADR 1 or ADR 2 data was recorded.

2.8 Information on Tests and Researches

2.8.1 Maintenance record of the Pitot Tubes

In a heavy maintenance work conducted from September to October 2015, an insulation resistance test (hereinafter referred to as the "IR test") of the three pitot tubes equipped on the Aircraft (No. 1 for the Captain, No. 2 for the Co-Pilot and No. 3 for the integrated standby instrument system) was conducted in accordance with the maintenance manual, and it was confirmed that the test results in all measurement points were within the specification. There is no

observation by the JMA.

*18 “CVR” stands for Cockpit Voice Recorder.

record of pitot tube replacement after the heavy maintenance.

No fault was found in the preflight inspection of the Aircraft on the day of serious incident. No damage was found on the three pitot tubes in the visual inspection after the arrival at Narita International Airport.

2.8.2 Tests of the pitot Tubes

In order to check the function of the three pitot tubes equipped on the Aircraft, test (IR test, power consumption test, and leak test) were conducted at the manufacturer of the pitot tubes from August 24 to 25, 2016. On pitot tube No. 2, bending was found in the incoming inspection and the IR test result was below the specification. No fault was found on pitot tubes No. 1 and No. 3.

2.9 Additional Information

2.9.1 Icing

The first half of the 2016 issue of AIM-j^{*19} (supervised by the Civil Aviation Bureau, Ministry of Land, Infrastructure, Transport and Tourism and the Japan Meteorological Agency (Chapter 8) June 20, 2016) states as follows:

856. SEVERE ICING e. Ice Crystal icing

High density ice crystals may be observed in the vicinity of convective weather areas that are accompanied by an active cumulonimbus. Ice crystals hardly ever accumulate over cold surfaces of the airframe, however, engine blades may be damaged, or abnormal vibrations are experienced by the ice crystals peeled off and collided with the second stage of the compressor after being accumulated on the engine compressor. Additionally, loss of power or flameout may be caused by sublimation of the ice crystals.

Ice crystals are generally not displayed on the airborne radar since they are in a form of fine particles, however, the high density ice crystals have been observed above and in the vicinity of intense rainfall area. A pilot is strongly suggested avoid any area which has moderate or strong echoes below (closer to icing altitudes), even if no echoes are observed at the flying altitude.

2.9.2 Information on Ice Crystals

2.9.2.1 Information from the Manufacturer

The Flight Crew Techniques Manual (hereinafter referred to as “the FCTM^{*20}”) from the manufacturer states as follows. (See Figures 6-1 to 6-3; refer to the FCTM provided to the Company). The revised FCTM that includes content related to ice crystals was provided to the Company on March 22, 2017, which was after the serious incident occurred. Before this revision, content focused on imparting knowledge about information on ice crystals had not been handled in the internal training at the Company.

^{*19} “AIM-j” stands for Aeronautical Information Manual Japan, which provides basic information needed for flying primarily in Japanese airspace, general flight procedures, and ATC procedures. It also provides basic information on weather, explanation of factors that affect flight safety, references that may be helpful for daily flight operations, and explanation of terms related to air traffic control.

^{*20} “FCTM” refers to a manual that supplements FCOM to provide pilots with practical information on how to operate the same aircraft model.

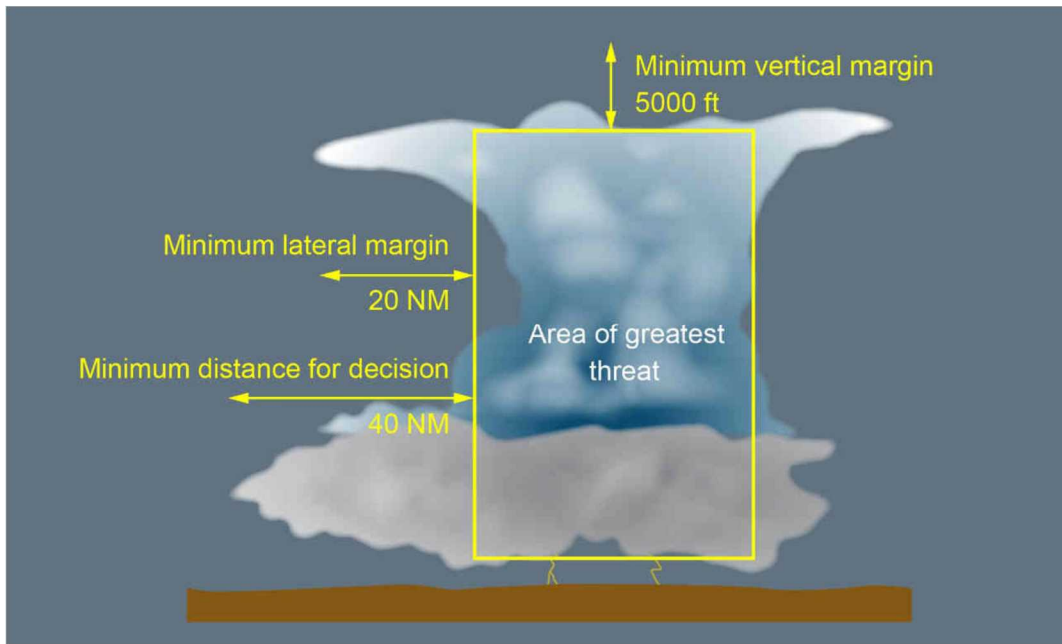

GENERAL

Clouds are made of particles of water that can be either liquid or solid. Ice crystals are very small solid water particles. In some areas, there may be a very high concentration of ice crystals that may have adverse effect on the aircraft.

Areas of ice crystals are usually next to, or above the core of convective clouds that have high-intensity precipitation. However, areas of ice crystals may sometimes even be several nautical miles away from the core of the associated convective cloud.

When ice crystals get in contact with a hot surface, they melt. Depending on the type of surface, a water film may appear. On the windshield, this water film creates not-expected appearance of “rain” at temperatures too low for liquid water to exist.

If there is a specific airflow towards a zone of the aircraft where water can build up, accretion may occur and create a block of ice. This is why flight in areas of ice crystals may result in various effects, for example engine vibrations, engine power loss, engine damage, or icing of air data probes.

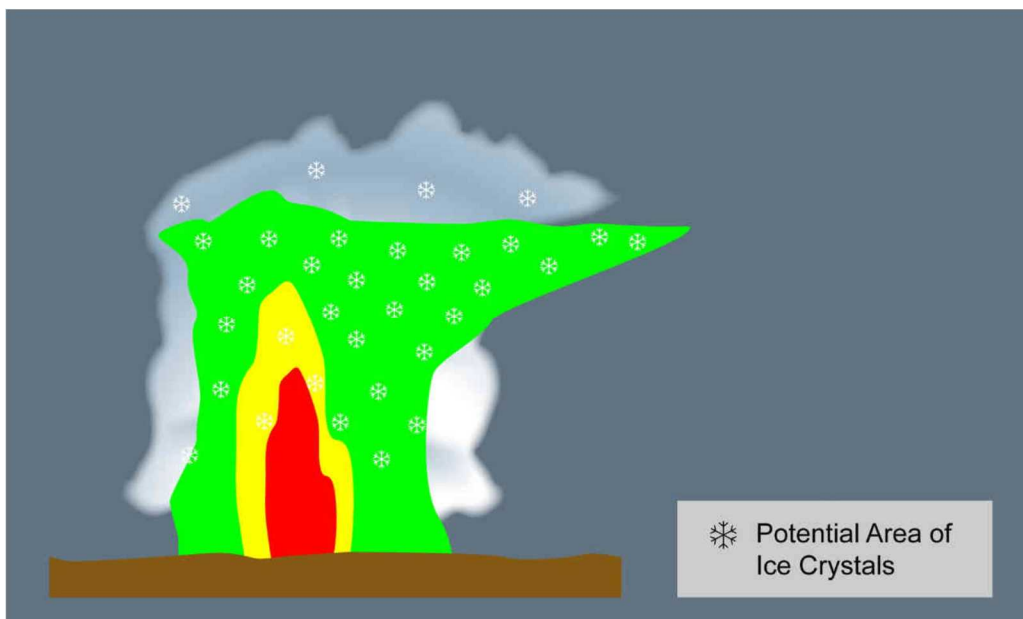

Isolated Continental Thunderstorm

DETECTION OF ICE CRYSTALS

Ice crystals are difficult to detect with the weather radar, because their reflectivity is very low due to both their small size and solid state. In addition, in areas of ice crystals, the flight crew should not expect significant icing of the airframe. This is because ice crystals bounce off cold aircraft surfaces. This is why even the ice detection system does not detect ice crystals, because ice crystals do not build up on ice detectors and visual ice indicators.

However, areas of ice crystals are usually associated with visible moisture. Ice crystals can be indicated by one or more of the following:

- Appearance of rain on the windshield at temperatures too low for rain to exist. This “rain” is usually associated with a “Shhhh” noise
- Small accumulation of ice particles on wipers
- Smell of ozone or Saint Elmo’s fire
- Aircraft TAT indication that remains near 0 °C (due to freezing of the TAT probe)
- Light to moderate turbulence in IMC at high altitude
- No significant radar echo at high aircraft altitude, combined with:
 - High-intensity precipitation that appears below the aircraft, or
 - Aircraft position downwind of a very active convective cloud.

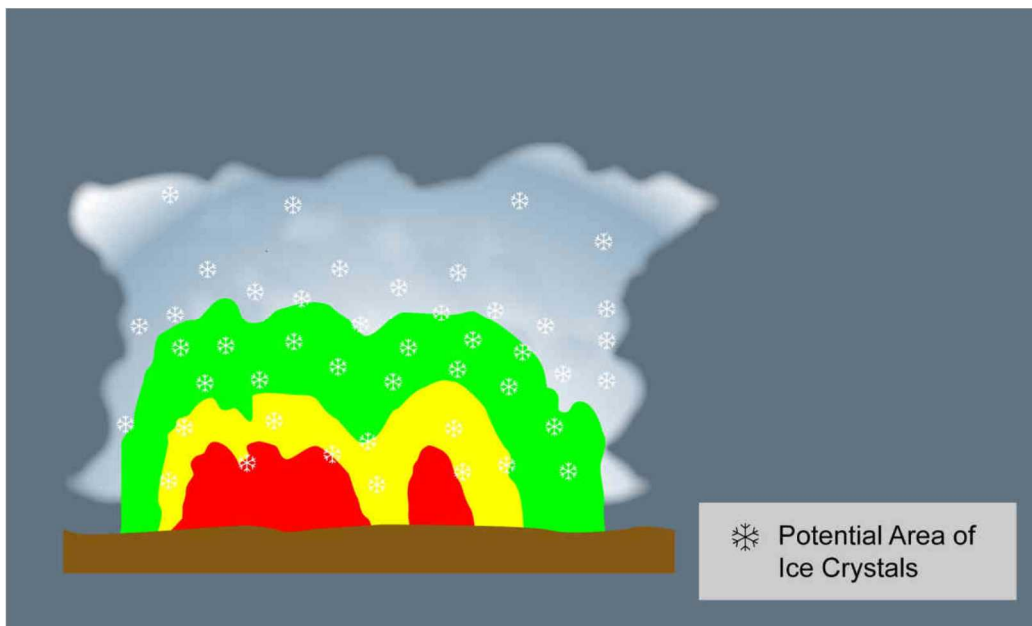

Mesoscale Convective Cloud

OPERATIONAL RECOMMENDATIONS FOR ICE CRYSTALS

If possible, the flight crew should avoid flight into areas that have a high concentration of ice crystals. The following recommendations apply:

- Use the water radar:
 - Identify areas that have a strong echo, and perform a detailed analysis of the structure of the convective clouds
 - If necessary, use the weather radar manual modes for a more precise analysis
 - Pay particular attention to strong echoes below the aircraft and to downwind areas.
- To avoid convective clouds, comply with operational recommendations (Refer to AS-WXR Operations in Convective Weather), particularly:
 - Prefer lateral to vertical avoidance

- *Comply with the avoidance margins*
- *Deviate upwind instead of downwind.*

If the aircraft encounters ice crystals precipitation despite avoidance action, and if this results in engines or probes misbehaviors, the published procedures and recommendations apply, and in particular:

- *ECAM alerts related to engine failure or engine stall*
- *ECAM alerts related to probe failure*
- *QRH procedures such as the ones linked to unreliable airspeed indication, engine vibrations, engine relight in flight...*

2.9.2.2 Information from the Federal Aviation Administration

The AC^{21*22} (AC91-74B Pilot Guide: Flight in Icing Conditions) from the Federal Aviation Administration (hereinafter referred to as “the FAA”) states on convective weather and icing as follows:

2-4. CONVECTIVE WEATHER AND ICE CRYSTALS.

a. Convective Weather Systems.

Convective weather systems, especially those associated with tropical weather fronts, can pump large quantities of moisture to high altitudes that freezes into ice crystals that can remain aloft. These ice crystals can remain as a cloud well after the convective system has decayed. Clouds and temperatures less than 10 °C are better indicators of the possible presence of ice crystals when near convective weather.

b. Hazards.

Above flight level (FL) 250, clouds contain little liquid water and mostly contain ice particles. These clouds with no liquid water have about 20 times less radar reflectivity than rain drops, and therefore are difficult to detect. Airborne weather radar will receive little to no returns at these altitudes unless it is tilted down to lower altitudes near or below the freezing level. Strong returns from the lower altitudes indicate the possibility of hail, severe turbulence, or large quantities of ice crystals that could be encountered above and accrete inside turbine engines when overflying these areas. Large deposits may ultimately result in engine upset, engine damage from ice shedding, power loss, or engine shutdown.

(Omission)

3-11. EFFECTS OF ICING ON CRITICAL SYSTEMS.

a. Pitot Tube.

The pitot tube is particularly vulnerable to icing because even light icing can block the entry hole of the pitot tube where ram air enters the system. This will affect the airspeed indicator and is the reason most airplanes are equipped with a pitot heating system. The pitot heater usually consists of coiled wire heating elements wrapped around the air entry tube. If the pitot tube becomes blocked, and its associated drain hole remains clear, ram air no longer is able to enter the pitot system. Air already in the system will vent through the drain hole, and the remaining will drop to ambient (i.e., outside) pressure. Under these circumstances, the airspeed indicator reading decreases to zero

*21 “AC” stands for Advisory Circular, which is published by the FAA to provide professionals in the aviation industry with useful information.

because the airspeed indicator senses no difference between ram and static air pressure. If the pitot tube, drain hole, and static system all become blocked in flight changes in airspeed will not be indicated, due to the trapped pressures. However, if the static system remains clear, the airspeed indicator would display a higher than-actual airspeed as the altitude increased. As altitude is decreased, the airspeed indicator would display a lower-than-actual airspeed.

(Omission)

c. Stall Warning Systems.

(1) Stall warning systems provide essential information to pilots. A loss of these systems can exacerbate an already hazardous situation. These systems range from a sophisticated stall warning vane to a simple airflow-activated stall warning switch. The stall warning vane (also called an “AOA sensor” since it is a part of the stall warning system) has a wedge-like shape, has freedom to rotate about a horizontal axis, and is connected to a transducer that converts the vane’s movements into electrical signals transmitted to the airplane’s flight data computer. Normally, the vane is heated electrically to prevent ice formation. The transducer is also heated to prevent moisture from condensing on it when the vane heater is operating. If the vane collects ice, it may send erroneous signals to such equipment as stick shakers or stall warning devices. Aircraft that use a stall horn connected to the stall warning switch may not give any indication of stall if the stall indicator opening or switch becomes frozen.

(Omission)

f. Outside Air Temperature (OAT)/True Air Temperature (TAT) Probe.

(1) Ice crystals can clog and freeze over the heated temperature probe on some aircraft. This tendency to freeze over appears to be sensitive to the location of the probe on the airframe. If the OAT/TAT probe freezes over, the indicated temperature will erroneously rise to 0 °C and hold. In this situation, some aircraft systems will alert the flight crew that there is a disagreement between various ambient temperature sensors, thus indicating the presence of ice crystals.

(Omission)

5-7. CRUISE.

An aircraft that is certificated for flight in icing conditions will be able to cope with most icing encounters provided that its ice protection systems are operating properly and that the exposure is not extended beyond their capabilities. However, if it is possible to exit the icing conditions by a change in altitude or flight path, this is certainly advisable (see Chapter 3, paragraph 3-13). During any icing encounter, the pilot should carefully monitor the behavior of the aircraft and know when to activate the airplane’s anti-ice and deicing systems. Unless otherwise stated in the flight manual, the pilot should activate pneumatic boot deicing systems at the first sign of ice accretion.

(Omission)

g. Airspeed Monitoring.

It is critical that the pilot monitor airspeed to assure that at least the minimum flight speed for the configuration and environmental conditions is maintained. There have been events in which the airspeed loss from cruise to stall occurred in a matter of minutes.

h. Weather Systems.

The pilot should exercise care when operating turbine engine powered aircraft in or around convective weather systems. Ice crystals can be accreting in the engine even though the airframe and ice detectors may not show any indications of an icing environment. This can occur at very low ambient temperatures and high altitudes. The pilot should activate nacelle and engine anti-ice systems if the presence of ice crystals is suspected and follow the procedures outlined in the aircraft's AFM as needed.

2.9.3 Information on Unreliable airspeed indication

The FCTM provided by the manufacturer states on Unreliable airspeed indication as outlined below:

(1) The most probable reason for erroneous airspeed and/or altitude information is an obstruction of the pitot and/or static probes. The ADRs detect most of the failures affecting the airspeed or altitude indications. These failures lead to lose the associated speed or altitude indications in the cockpit and trigger the associated ECAM alerts.

(2) The "UNRELIABLE SPEED INDICATION" procedure has two objectives:

- To fly the aircraft,*
- To identify and isolate the affected ADR(s).*

It includes the following steps:

- 1. Memory items*²². (if necessary),*
- 2. Flight path stabilization,*
- 3. Troubleshooting and isolation,*
- 4. Flight using pitch/thrust references*

(3)IN-SERVICE EXPERIENCE OF HIGH ALTITUDE PITOT OBSTRUCTIONS

Analysis of the in-service events shows that:

- The majority of unreliable speed events at low altitude are permanent situations, due to the obstruction of pitot probes by rain, severe icing, or foreign objects (refer to the table above).*
- At high altitude, typically above FL 250, the cases of unreliable speed situation are mostly a temporary phenomenon: They are usually due to contamination of the pitots, by water or ice, in particular meteorological conditions. In-service experience shows that such a contamination typically disappears after few minutes, allowing to recover normal speed indications.*

2.9.4 NAV ADR DISAGREE Indication

The Aircraft is equipped with three ADIRUs*²³. The ADR*²⁴, which is one of the units that constitutes an ADIRU, receives air data from the angle of attack (AOA) sensor, pitot tubes, static

*²² "Memory Items" stands for emergency procedures which are necessary for flight crews to perform immediately in their memories.

*²³ "ADIRU" stands for Air Data/Inertial Reference Unit. It integrates an ADR unit that collects air data of the aircraft and an IR unit that collects location and other information. Information from ADIRU 1 is displayed on the PFD and ND on the Captain's side, and information from ADIRU 2 is displayed on the PFD and ND on the Co-Pilot's side. Information from ADIRU 3 can be displayed either on the Captain's or Co-Pilot's side as required.

*²⁴ "ADR" stands for Air Data Reference, which is a unit that collects the air data (airspeed information and altitude information) of the aircraft.

ports and TAT*²⁵ probe. Air data from the pitot tubes and static ports are converted by the ADM*²⁶ into electrical signals, which are sent to each ADIRU. (See Figure 7 Conceptual diagram of the airspeed system.) ADR data from the three systems (ADR 1, ADR 2 and ADR 3) that is input to the computer (ELAC*²⁷) are calculated to determine the median, which is used for comparison with ADR data to determine the correctness of each ADR datum. If determined to be correct by the computer, that data is output to another computer that controls flight operation.

If the following event occurs, AP and AT are automatically turned off, and the caution message “NAV ADR DISAGREE” is displayed on the ECAM.

- One of the ADRs is determined to be faulty or its data that were input to the ELAC are determined to be incorrect, and there is disagreement between data (airspeed or AOA) from the remaining two ADRs.

If the ADR data were incorrect only temporarily and correct data have been resumed, the disabled AP and AT can be turned on again by the pilot.

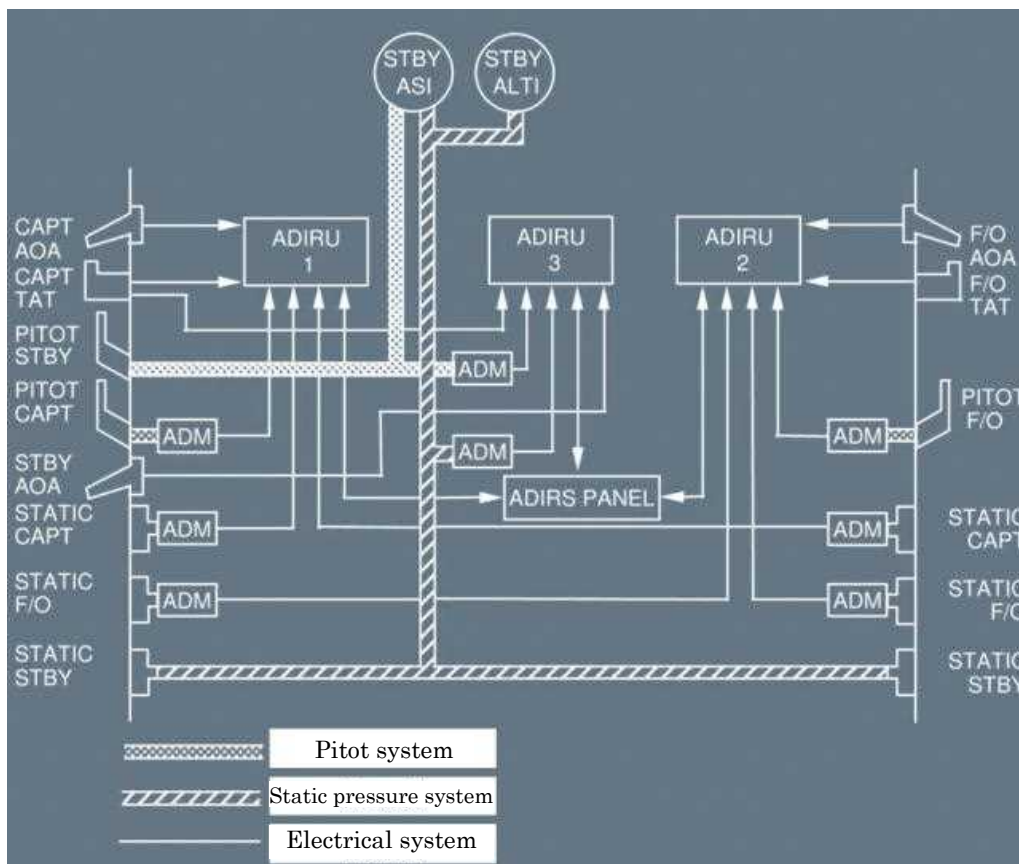

Figure 7: Conceptual diagram of the airspeed system

With regard to the relationship between ADR and PFD, ADR 1 data are displayed on the PFD for the left seat, and ADR 2 data are displayed on the PFD for the right seat. Although ADR 3 data are displayed on the integrated secondary flight display system, it can also be displayed on the PFD

*²⁵ “TAT” stands for Total Air Temperature. It refers to the stagnation point temperature in a flow. In the case of aircraft, the outside temperature is determined by converting from TAT and airspeed.

*²⁶ “ADM” stands for Air Data Module that converts air data from the pitot tubes and static ports into electrical signals. Those signals are sent to electronic equipment such as the ADIRU as required.

*²⁷ “ELAC” stands for Elevator Aileron Computer, which transmits calculated pitch and roll attitude commands to the relevant flight control servos to operate them.

for the right or left seat by switching.

2.9.5 F/CTL ALTERNATE LAW Indication

On the Aircraft, there is a relationship called Law between input to the side-stick operated by the PF to control the Aircraft and its response. When a failure occurs in the flight control system or its related equipment, the computer changes the Law of the flight control system from the Normal Law*28 to the Alternate Law or Direct Law*29 depending on the stage of the failure.

The unreliable airspeed indication that occurred on the Aircraft caused the Law of the computer to change from the Normal Law to the Alternate Law. As a result, the protection function to prevent stalling (high angle of attack protection) and the protection function to prevent overspeed (high speed protection) stopped, the caution message “F/CTL ALTERNATE LAW” appeared on the ECAM, and an amber “x” mark was displayed on the PFD. (See Figure 8 Change from Normal Law to Alternate Law displayed on the PFD.)

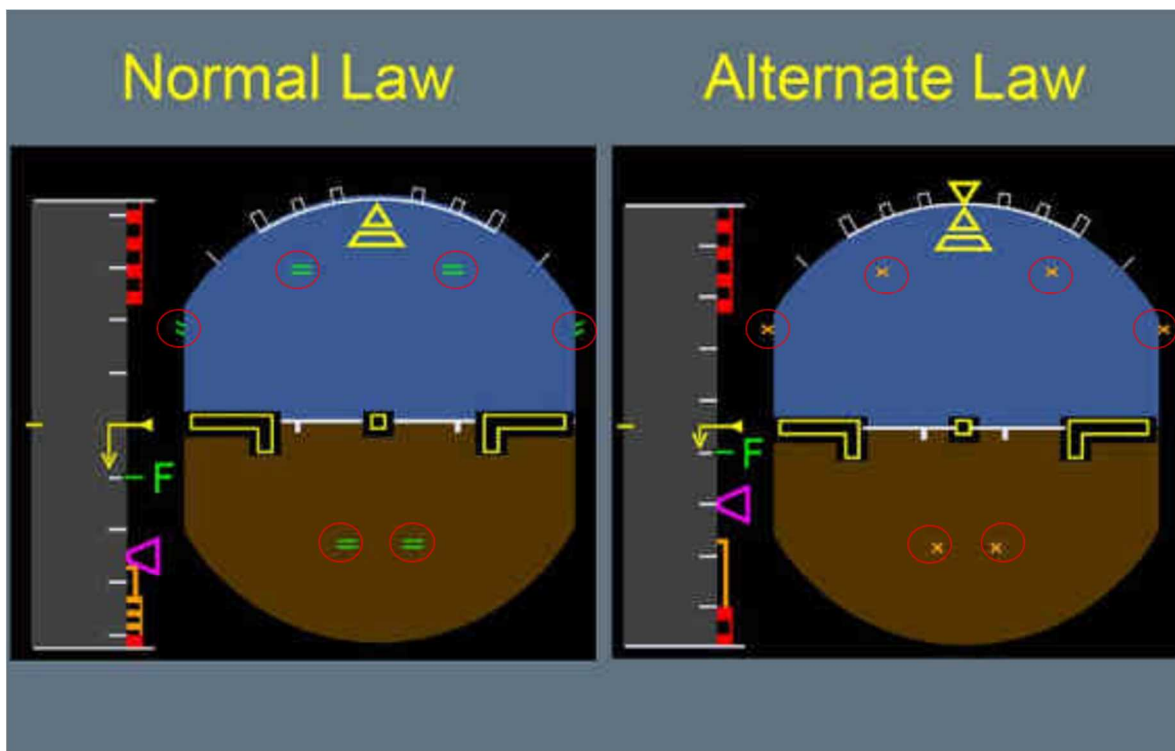

Inside red circles
Normally, green “=” marks are displayed.

Inside red circles
Green “=” marks change to amber “x” marks.

Figure 8: Change from Normal Law to Alternate Law displayed on the PFD

2.9.6 Aircraft System

2.9.6.1 Probe Ice Protection

The air data probes (AOA sensor, pitot tubes, static ports and TAT probe) on the Aircraft are electrically heated to prevent icing. To ensure that reliable information is obtained from the air

*28 Under “Normal Law,” the control-related computers attempt to keep the aircraft within the predetermined limit of flight range, and a protection function operates when the pilot has made excessive control.

*29 Under “Direct Law,” the protection function for keeping the aircraft within the limit of the flight range stops when two or more control-related computers have failed.

data system, the air data probes are automatically heated while at least one engine is operating. Each air data probe is connected to each channel of the air data system. The heater system in each channel is controlled by the probe heater computer.

2.9.6.2 Window Heat

The probe ice protection device on the front cockpit window and the defogging device on the side windows are electrically heated. They are automatically heated while at least one engine is operating.

2.9.6.3 Ice Indicator

The ice indicator on the Aircraft is the protruding part on the outside of the front cockpit window, which is used by the Captain and Co-Pilot to visually check for icing. (Refer to Photo 1 Ice indicator on the Aircraft.)



Photo 1: Ice Indicator on the Aircraft

2.9.6.4 Weather Radar

The weather radar on the Aircraft sends short-wavelength radio waves to the front of the Aircraft.

It analyzes the reflected radio waves and constructs a three-dimensional image that shows cloud conditions ahead of the Aircraft. The image can be displayed on the ND during flight by selecting the relevant image display mode. The color identification of the radar echoes displayed on the ND is related to precipitation and radar reflectivity, using green^{*30}, yellow, and red in ascending order of strength. There are three image display modes, as outlined below:

- (1) ALL: Displays the range of 80° on the right and left, and 15° up and down with respect to the direction of the flight route.
- (2) ON PATH: Displays 80° on the right and left, and ± 4,000 ft up and down with respect to the direction of the flight route.
- (3) ELEVATION: Displays 80° on the right and left with respect to the direction of the flight route at the selected flight altitude

2.9.7 Messages Recorded on the Aircraft

In the aircraft equipment (CFDIU^{*31}) that records the condition of the aircraft in flight, which is equipped in the aircraft, there are recorded two kinds of messages related to the state of the aircraft displayed during the flight and messages related to the fault of the aircraft. Also, many of the equipment of the Aircraft have the BITE^{*32} function, and can record faults and transmit fault information to CFDIU. From the CFDIU after landing, the record related to this serious incident

*30 A “green” echo is displayed on the ND when the intensity of the reflection of the beam emitted from the Airborne weather radar is weak with a reflectivity of 20 to 30 dBZ and rainfall is 0.7 to 4.0 mm per hour. A yellow echo is displayed when the beam reflectivity is 30 to 40 dBZ and rainfall is 4.0 to 12.0 mm per hour. A red echo indicates a reflectivity of 40 dBZ or more and a rainfall of 12.0 mm or more per hour.

*31 “CFDIU” is an abbreviation for Centralized Flight Data Interface and Management Unit, and refers to a device that receives and processes various parameters of the aircraft with a digital signal or the like.

*32 “BITE” stands for Built-in Test Equipment and refers to a self-diagnostic device incorporated in equipment such as avionics.

was taken out as post-flight data^{*33}. Major post flight data of the aircraft are as follows.

- (1) Messages concerning faults of the aircraft
 - 09: 37, Record that the signal from ADR 2 was not normal
 - 09: 38, Record that the signal from ADR 1 was not normal
- (2) Messages concerning the state of the aircraft
 - 09: 37, Record that the message “F / CTL ALTERNATE LAW” was indicated
 - 09: 37, Record that the message “NAV ADR DISAGREE” was indicated

2.9.8 Issuance of TCD(Japanese Airworthiness Directive)-5734B-2015

EASA^{*34} issued AD^{*35} to the same model in October 2014 in order to replace the part number C16195AA type with the C16195BA type pitot tube which was enhanced anti-ice performance. Thereafter, the outline of the content of the latest version of AD issued on October 09, 2015, which was twice revised, is as follows.

In order to prevent the fault causing airspeed indication failure, which is caused by the pitot tube being affected by certain weather conditions, replacement of the pitot tubes with the C16195BA type was required; but there was no evidence that the C16195BA type pitot tube was strong enough to withstand the ice crystals at very high altitudes. For that reason, we ask for a change to a further improved type of pitot tube.

In response to this, the Civil Aviation Bureau issued the TCD-5734B-2015 including the same content even in Japan.

The pitot tube of the aircraft was equipped with a pitot tube of part number type 0851HL manufactured by UTAS Co., which further improved anti-freeze capability from the time of manufacturing the aircraft.

2.9.9 Revised regulations for Airspeed System

In March 2015, EASA revised the design standards for the airworthiness classification transportation type T (CS25) and for the engines (CSE), and introduced the requirement to prove that an airspeed indicator probe functions properly under each of the newly set conditions where Supercooled large droplets^{*36} exist, conditions where Supercooled large droplets and Ice crystals exist together, as well as conditions where Ice crystals exist; but this requirement is to be applied to aircraft that newly apply for aircraft design after March 12, 2015, and is not applied to the Aircraft.

2.9.10 Related Information

- (1) As examples of the pitot tube not working properly due to the effect of the Ice crystals causing an unreliable airspeed, there are the aviation accidents of Air France AF447 flight off the Atlantic Ocean on June 1, 2009 and the incidents of Jetstar 12 flight off the Pacific Ocean on October 28, 2009.

*33 “Post flight data” is a record that helps the mechanic to easily search for faults, it is recorded and indicated only for hours and minutes, but there is no indication in seconds.

*34 “EASA” stands for European Aviation Safety Agency.

*35 “AD” is an abbreviation of Airworthiness Directive, which refers to the documents that request actions to restore the aircraft and other vehicles to an acceptable level of safety. The AD referred to here is the one issued by the EASA.

*36 “Supercooled large droplets” refers to water droplets that do not freeze even when water reaches 0°C, and are of somewhat larger sizes. In addition, supercooled water droplets also cause icing.

- (2) As the response of Japanese airlines such as All Nippon Airways Co., Ltd. and Star Flyer Inc., in light of the issuance of the AF447 flight accident report, the airlines operating the Airbus A320 are alerting their staff with regards to Unreliable Airspeed with their own analysis in their safety information sheets issued in-house.

3. ANALYSIS

3.1 Qualification of Flight Crew Members

Both the Captain and the Co-pilot held both valid airman competence certificate and valid aviation medical certificate.

3.2 Aircraft Airworthiness Certificate and others

The Aircraft had a valid airworthiness certificate and had been maintained and inspected as prescribed.

3.3 Relations to the Meteorological Conditions

As described in 2.6.1(1), it is highly probable that there was a severe rainfall phenomenon in the area from West Japan to the Pacific Ocean side of East Japan where this serious incident occurred, caused by warm and humid air from the south, flowing towards the front and low pressure area. Also, as convective system became active due to the influx of warm and humid air, it is highly probable that a cumulonimbus with echo peak altitude ranging from 12 to 14 km (from 39,370 to 45,931 ft) was generated as described in 2.6.2. Furthermore, it is highly probable that from the forecasted significant weather described in 2.6.1 (2), that there were ordinary turbulence and icing, rain, lightning strikes and cumulonimbus in the adverse weather area (in the clouds).

As described in 2.1.2, the Captain and Co-Pilot state that they heard the sound like as rain drops hitting the cockpit window at -44°C, with the airborne weather radar echo in the green air space; but in general, the limit for naturally occurring water to remain a liquid under supercooled conditions is considered to be around -40°C. Therefore, as described in 2.9.6.2, it is somewhat likely that the melting of ice crystals on the cockpit window, which is electrically heated to prevent icing. In addition, as described in 2.1.2 by the Captain and Co-Pilot, as well as the information on ice crystals in 2.9.2, as there were no traces of icing on the wings and the ice indicator of the Aircraft after hearing the sound like as raindrops hitting the window, it is somewhat likely that the aircraft encountered ice crystals existing near or above the center of the cumulonimbus, which formed due to highly active growth existing in the weather front. It is probable that the temporary unreliable airspeed indication on the Captain's side and the Co-Pilot's side due to icing of the No. 1 and No. 2 Pitot tubes, while encountering ice crystals.

3.4 Events Related to the Aircraft

3.4.1 Damage to No. 2 Pitot Tubes

Regarding the No. 2 Pitot tube, there was no failure after heavy maintenance as described in 2.5.3 and it was not replaced, and there was no clear record in the post-flight data described in 2.9.7, showing that it failed. Also, as described in the statement of the Captain in 2.1.2, it is probable that the Captain was able to engage AP and AT again as the error in the ADR data described in 2.9.4 was temporarily occurred, caused by icing of the Pitot tube. For that reason, it is probable that when this serious incident occurred, the Pitot tube was not faulty. On the other hand, regarding the finding of a bend in the No. 2 Pitot tube during the incoming inspection by the

manufacturers described in 2.8.2, from the fact this damage was not found during the visual inspection after the serious incident described in 2.8.1 occurred, it is somewhat likely that the damage occurred when the Pitot tube was sent to the manufacturer, but it was not possible to determine this. In addition, it was not possible to determine the relationship between the unreliable airspeed indication and the bend of the Pitot tube.

3.4.2 Unreliable airspeed indication

As described in 2.7, as the CAS recorded on the FDR depends on data from either one of ADR1 or ADR2, normally if the data from ADR1 is invalid, it switches to data from ADR2; from the parameters recorded on the FDR and QAR (refer to Appended Figure 2), the statements of the Captain and the Co-Pilot described in 2.1.2, as well as the post flight data described in 2.9.7, the following analysis can be made regarding the passing of time and airspeed indication.

(1) From 09:37:42 to 09:37:53

According to QAR, AOAIRS2 was recorded as the NCD. From this, it is probable that up until this point, the CAS data of ADR2 was below 60kt. Meanwhile, since CAS did not fluctuate greatly, it is highly probable that CAS was data from ADR 1, and that the CAS data of ADR 1 was normal. Also, as described in 2.9.4, it is highly probable that the ELAC data temporarily gave an error due to the signal input from ADR 2 deviating far from the median value.

(2) From 09:37:53 to 09:38:21

It was recorded that the CAS was fluctuating in an extremely short period in the range of 260kt to 50kt in about 28 seconds, from 09:37:53 to 09:38:21. Regarding this, it is highly probable that the CAS data of ADR1, which was normal during this time, fluctuated, leading to the airspeed indicator on the Captain's side and the Co-Pilot's side, and flags appearing. Also, as described in 2.9.4, it is highly probable that NAV ADR DISAGREE was displayed because the data from ADR 2 was erroneous and the airspeeds of ADR 1 and ADR 3 became inconsistent.

According to FDR, AT and AP were automatically canceled at around 09:37:55, however the Captain voluntarily disconnected the AP at around 09:37:58. It is probable that this procedure was taken in recollection of the procedure corresponding to the unreliable airspeed indication. As described in 2.9.3, QRH describes the relationship between the aircraft attitude that should be used as a reference, and the engine output relative to the weight of the aircraft when the Unreliable airspeed indication occurs. As the statement of the Captain described in 2.1.2, the pitch attitude angle was set to near 2.5° in recollection of the procedure corresponding to the unreliable airspeed indication, and the engine output set to the CLIMB position, to continue to fly the aircraft safely in consideration of the day's weather conditions. After that, it is probable that the Unreliable airspeed indication was resolved in a short period of time.

(3) From 09:38:21 to 09:38:33

Since the AOA data recorded in the FDR greatly fluctuates and the AOAIRS1 data recorded in the QAR as the NCD, it is highly probable that the CAS data from ADR 1 was less than 60kt during this time. On the other hand, it is highly probable that the CAS data recorded in the FDR switched from ADR1 to ADR2, since the fluctuation of the CAS recorded in the FDR stopped.

(4) After 09:38:33

According to FDR, the pressure altitude rapidly changes from 37,500 to 36,900 ft at 9:38:33, compared with the change of the altitude information and the pitch attitude angle of the integrated standby instrument system, it is probable that it does not coincide with actual movement of the aircraft. Therefore, it is highly probable that the change in the pressure altitude is due to the switching of the data of the recorded static pressure system. If the CAS data recorded in the FDR was switched at this point, it is possible that the airspeed on the Captain's side recovered. According to the FDR, at around 09:39:20, the Captain reengaged the AT and AP. Regarding this, it is highly probable that erroneous data from ADR 1 and ADR 2 was temporary, as described in 2.9.4.

3.5 Avoiding ice crystals

It is highly probable that the Captain and the Co-Pilot had been flying through a route in the airspace where the echo intensity was relatively weak, as shown in Figure 4 with reference to the information on the airborne weather radar; but on the way to Narita International Airport it was necessary to cross the weather front and it is somewhat likely that the aircraft may have encountered ice crystals, as described in 3.3 ; however as described in 2.9.1, since the ice crystals are very small, it is probable that it was difficult for the Captain to directly detect them with the airborne weather radar. In order to predict and avoid similar events as much as possible, it is desirable for the Company to educate the relevant people in the Company, using the FCTM provided by the manufacturer described in 2.9.2.1.

In addition, the aircraft may have had the unreliable airspeed indication on the Captain's and Co-Pilot's side while encountering ice crystals, but in the short period of time from the occurrence of this event to the recovery of the unreliable airspeed indication, it is probable that the Captain and the Co-Pilot carried out the appropriate countermeasures so as to continue to fly the aircraft safely. Similarly to this case, when an event occurs where ice crystals are encountered and the unreliable airspeed indication continues, after stabilizing the aircraft by referring to the QRH related to the unreliable airspeed indication described in 2.9.3, as it is probable that it is important for safety reasons to escape from the existing ice crystal area early with the aircraft attitude and thrust maintained, it is desirable to call attention to the countermeasures in accordance with QRH to flight crewmembers.

4. PROBABLE CAUSES

It is probable that this serious incident occurred because the icing occurred in the Pitot tube when the aircraft was flying at an altitude of 37,000ft, which led to the temporary failure of airspeed indication on the Captain's side and Co-Pilot's side.

It is somewhat likely that the icing of the Pitot tube occurred because the aircraft flew in an ice crystal area that was existing in the vicinity of a cumulonimbus that grew to a high altitude.

5. SAFETY ACTIONS

5.1 Prevention Measures of Recurrence Taken After the Incident

5.1.1 Safety Actions Taken by the Company

- (1) As of August 1, 2017, the Company reflected in the company regulations, FCTM, about information related to ice crystals provided by the manufacturer, as well as distributed it to flight crewmembers in an electronic medium.
- (2) In the regular revision of the training procedures scheduled in July 2018, the Company will make an additional procedure in which flight crewmembers shall confirm the latest information regarding icing in a prior briefing on the Unreliable Airspeed in the regular training of using the Flight Simulator.
- (3) In the regular revision of the training procedures scheduled in July 2018, the Company will make an additional procedure in which Flight Dispatcher and Flight Dispatch Assistant shall confirm the latest information regarding icing in the regular training.

Appended Figure 1: Three-View Drawing of Airbus A320-232

Units: m

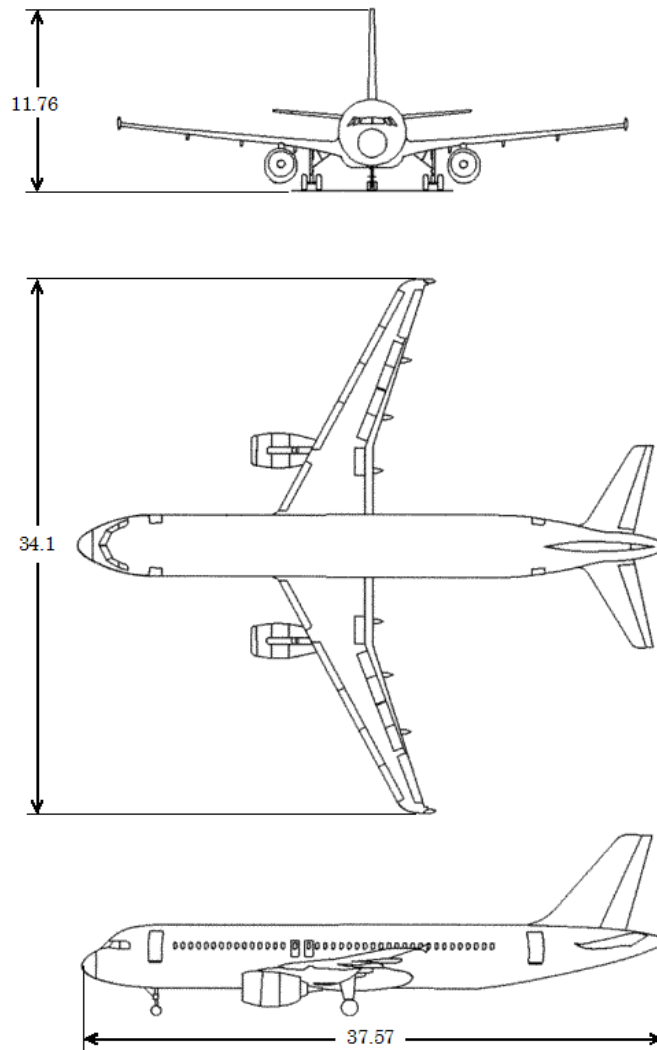

Photo 2: Serious incident aircraft



Appended Figure 2: Record of FDR and others

